

End Suction Centrifugal Pump



Applications

- Water supply systems
- Pressure boosting
- Heating systems for commercial buildings and district heating
- Cooling plants for industrial processing and air-conditioning units
- General transport for industrial processes
- Fire fighting system

Identification Codes

EEP 50-32-130 H(G)/139

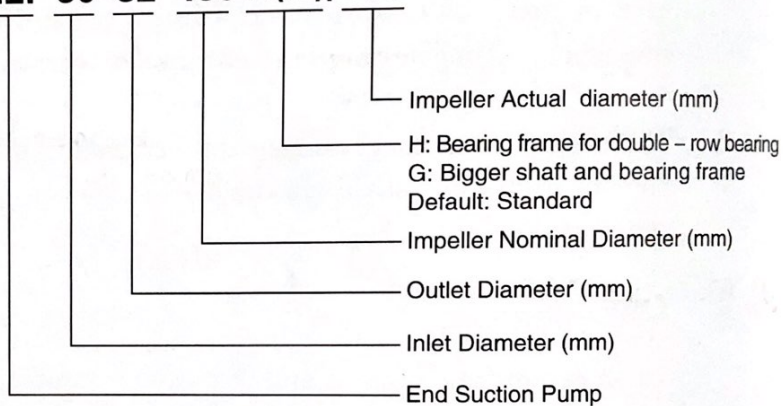

No.	Part	Material
1	Pump casing	Cast Iron Ductile Iron 304/316
2	Impeller nut	
3	Wear ring	
4	Impeller	Brass/Bronze Cast Iron 304/316
5	Casing cover	
6	Shaft spacer	
7	Mechanical seal	
8	Seal cover	
9	Rubber slinger	
10	Bearing frame	
11	Shaft	304/316/1045

No.	Part	Material
12	Bearing	
13	Bearing cover	
14	Support foot	
15	Packing sleeve	Bronze
16	Packing seal cage	
17	Gland packing	
18	Gland cover	
19	Casing gasket	
20	Nut	
21	Nut	
22	Nut	

No.	Part	Material
23	Key	
24	Key	
25	Bolt	
26	Oil nipple	
27	Oil seal	
28	Nut	
29	Washer	
30	Washer	
31	Oil scale	
32	Oil cover	
33	Bearing Cover Gasket	

Working Conditions

- Pump design complies to BS EN 733/DIN 24255 standard
- Conveying medium: Low viscosity, non-inflammable and non-explosive liquids not containing solid particles or fibers
- Speed: 1450/2900 rpm at 50 Hz, 1750/3500 rpm at 60 Hz
- Flow range: 0.5 - 440 l/s
- Head range: 2 - 152 m
- Max. liquid temperature: 105°C
- Liquid pH value: 4 - 10
- Max. operation pressure: 10 bar, 16 bar on request

Design & Structure

Design	Performance and dimensions referring to the European standard BS EN733/DIN24255
Structure	Horizontal, Axial End-Suction, Single-Stage, Single-Suction, Volute Casing, Back pull-out
DN(mm)	Inlet: 50-350 Outlet: 32-300
Flange	ISO7005.2 ; DIN2501 PN16 ; GB/T17241.6 PN1.6

Materials Table

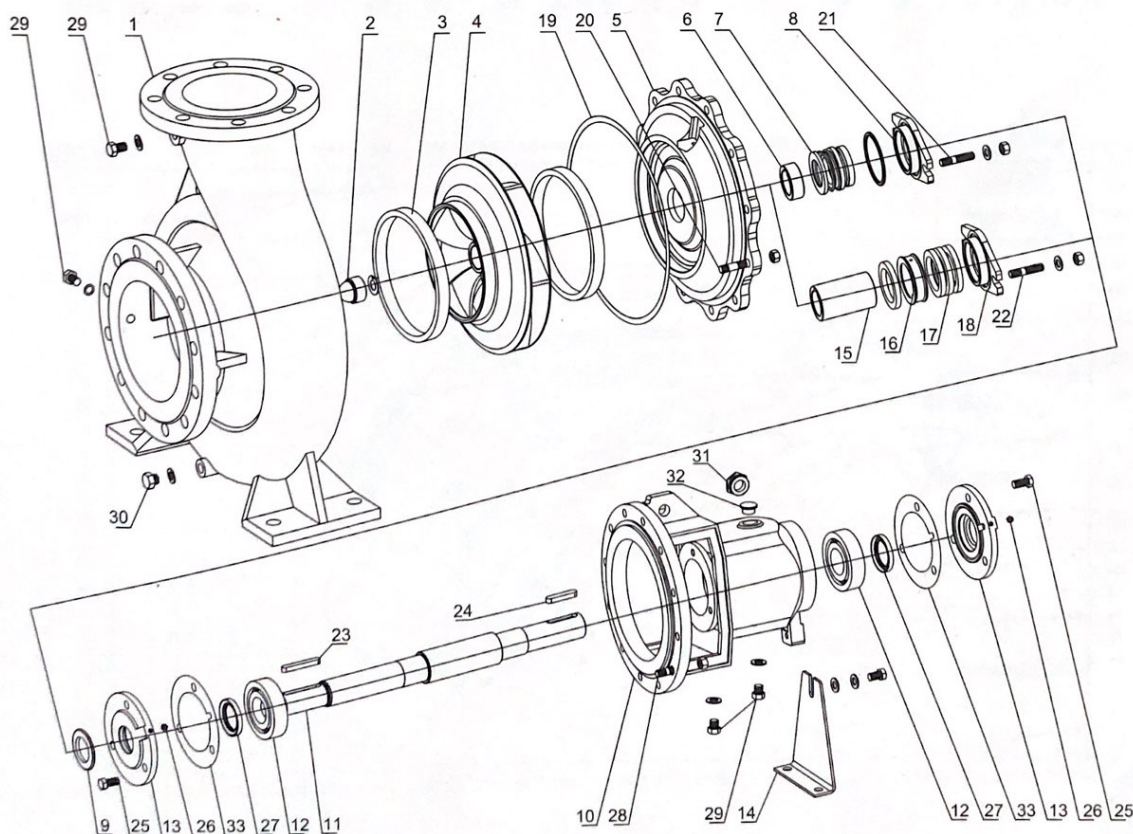

Characteristic Curves

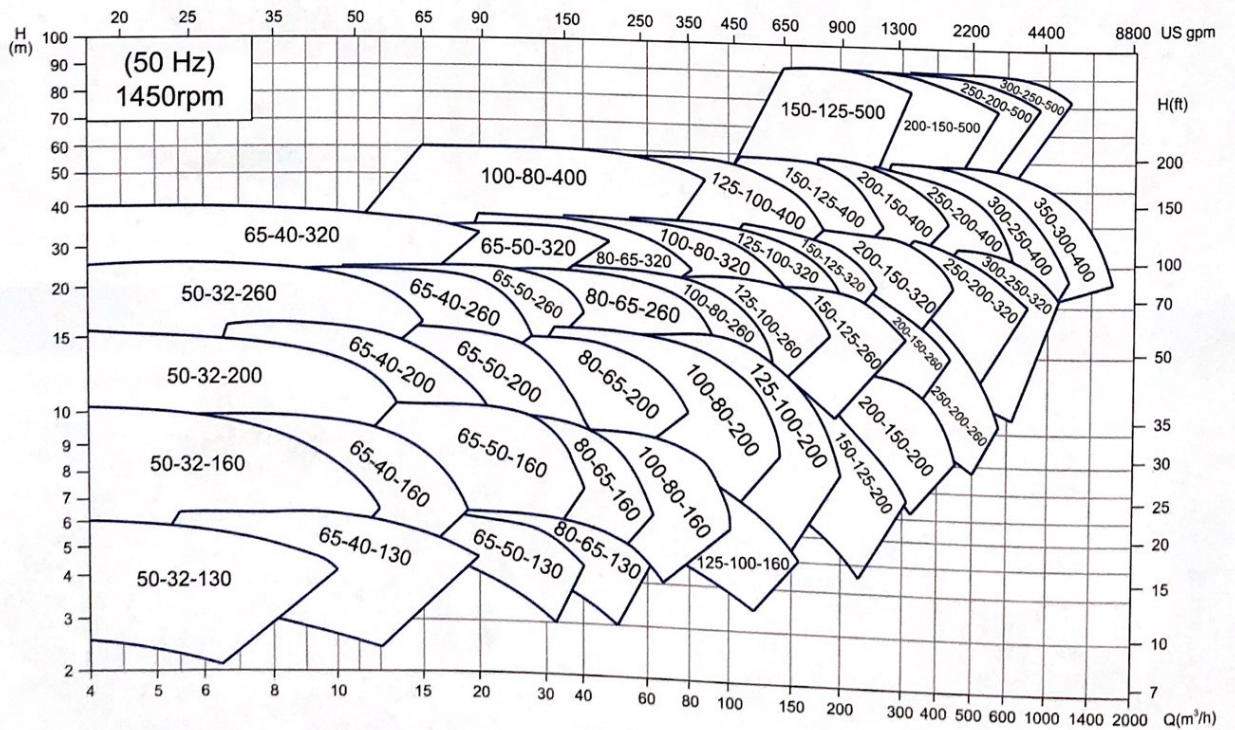
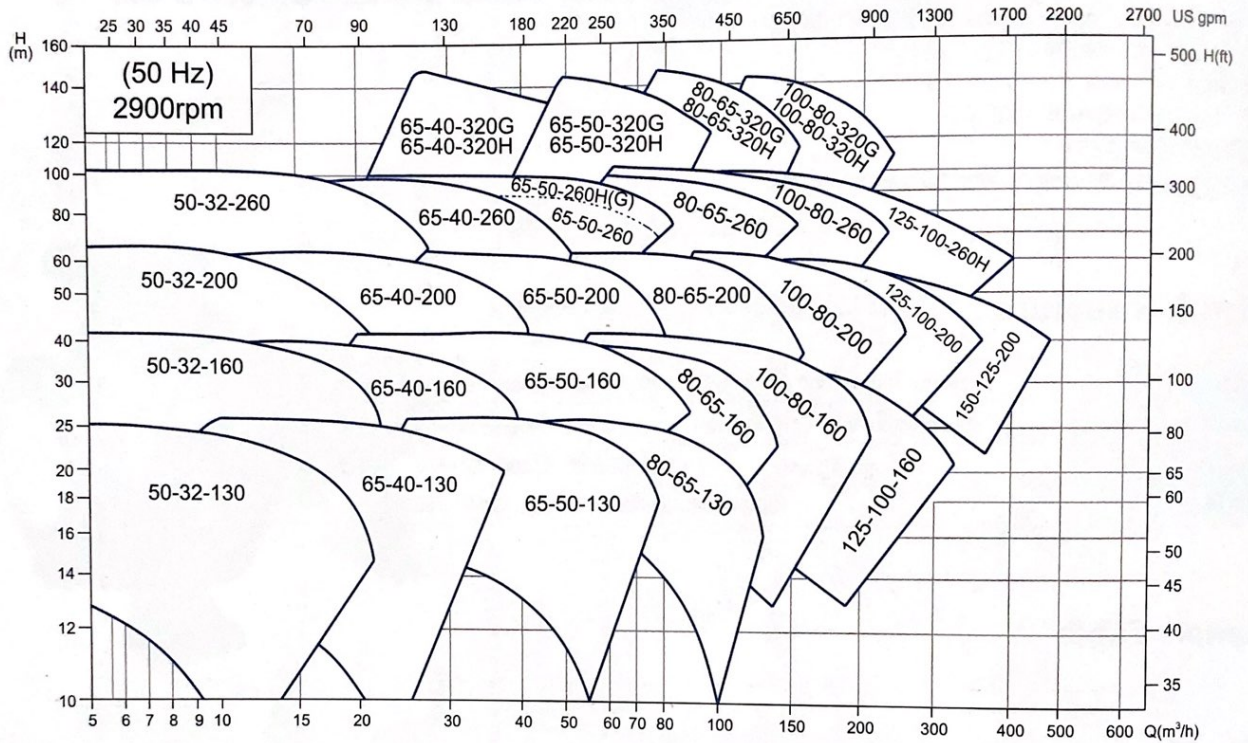

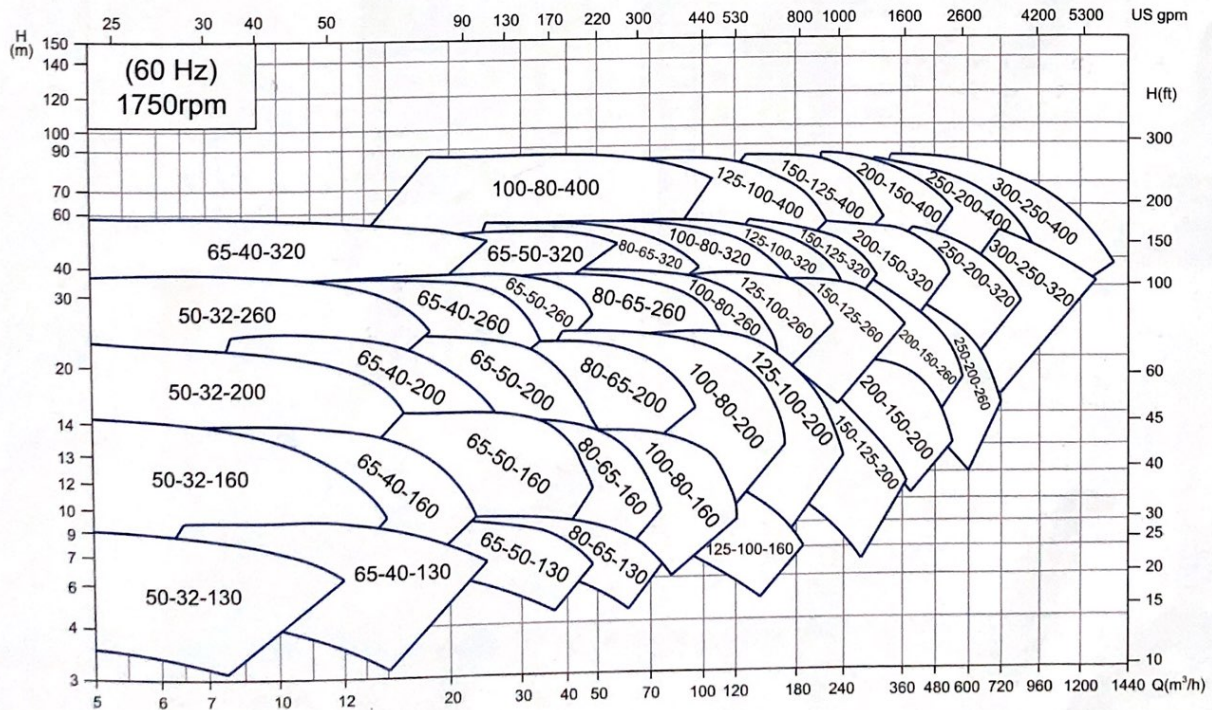
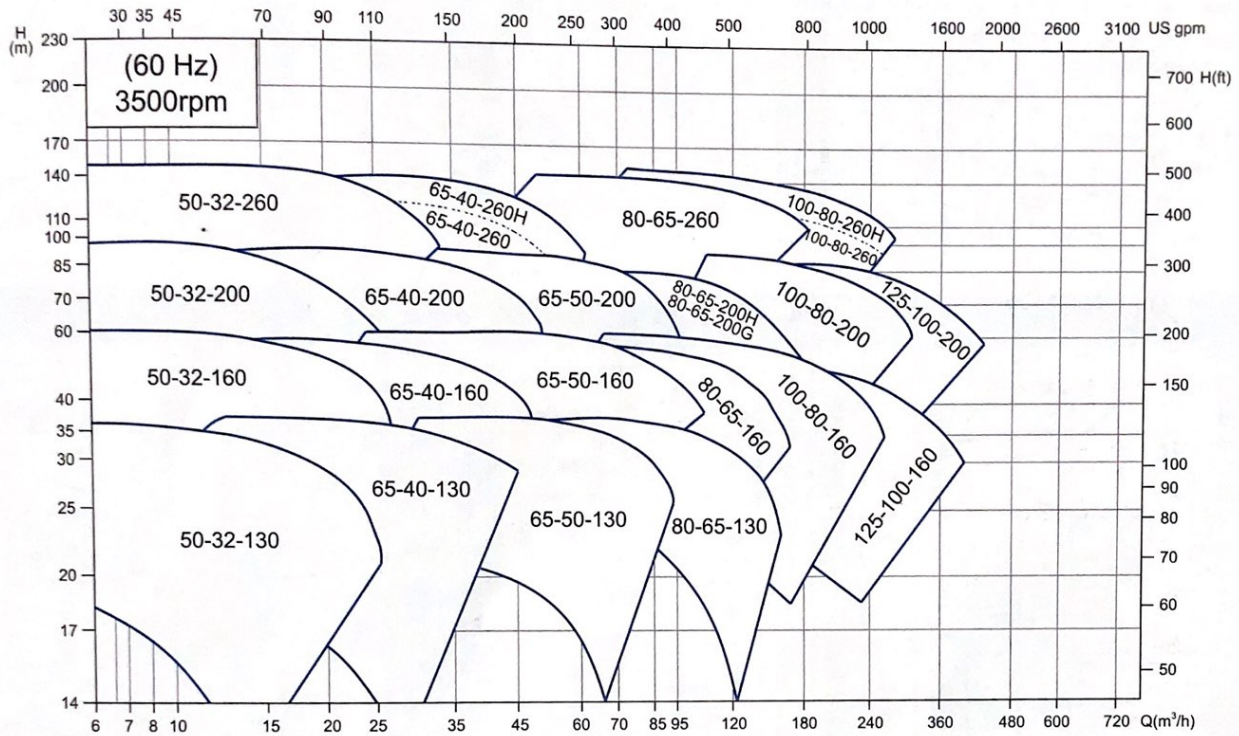

Installation Dimensions

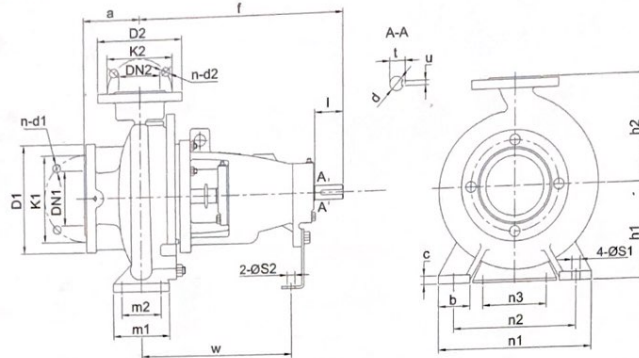

Model	Bearing ID (mm)	DN2	DN1	a	f	h1	h2	b	c	n3	m1	m2	n1	n2	S1	S2	w	d	l	t	u	Weight (Kg)							
EEP50-32-130	25	32	50	80	360	112	140	50	14	100	100	70	190	140	14	14	267	24	50	27	8	29							
EEP50-32-160						132	160						240	190								35							
EEP50-32-200						160	180						240	190								47							
EEP50-32-260	100	100	100	100	180	225	65	110	125	95	320	250	210	160	58														
EEP65-40-130	25	40	50	80	360	112	140	50	14	100	100	70	190	140	14	14	267	24	50	27	8	31							
EEP65-40-160						132	160						240	190								34							
EEP65-40-200						160	180						265	212								45							
EEP65-40-260(H)	100	100	100	100	180	225	65	110	125	95	345	280	320	250	61														
EEP65-40-320	35	35	35	35	470	200	250	65	14	110	125	95	345	280	342	32	80	35	10	94									
EEP65-40-320(H)	45	45	45	45	526	200	250	65	14	110	125	95	345	280	367	42	110	45	12	107									
EEP65-40-320G	25	25	25	25	360	132	160	50	14	100	100	70	265	212	14	14	267	24	50	27	8	35							
EEP65-50-130	25	50	65	100	360	132	160	50	14	100	100	70	265	212	14	14	267	24	50	27	8	39							
EEP65-50-160						160	180						265	212								49							
EEP65-50-200						160	200						265	212								68							
EEP65-50-260(H)	35	35	35	35	470	180	225	65	14	110	125	95	320	250	344	32	80	35	10	65									
EEP65-50-260G	45	45	45	45	526	200	250	65	14	110	125	95	345	280	342	32	80	35	10	113									
EEP65-50-320(H)	25	25	25	25	360	160	180	50	14	100	100	70	265	212	14	14	267	24	50	27	8	105							
EEP65-50-320G	35	35	35	35	470	180	225	65	14	110	125	95	345	280	367	42	110	45	12	105									
EEP80-65-130	25	80	100	360	360	160	180	65	14	100	100	70	240	190	14	14	267	24	50	27	8	41							
EEP80-65-160						160	180						280	212								47							
EEP80-65-200(H)						180	225						320	250								55							
EEP80-65-200G	35	35	35	35	470	200	250	65	14	110	125	95	345	280	339	32	80	35	10	60									
EEP80-65-260	45	45	45	45	526	200	250	65	14	110	125	95	345	280	342	32	80	35	10	87									
EEP80-65-320(H)	25	25	25	25	360	225	280	80	18	110	160	120	360	280	18	18	342	32	80	35	10	110							
EEP80-65-320G	35	35	35	35	526	225	280	80	18	110	160	120	400	315	18	18	367	42	110	45	12	120							
EEP100-80-160	25	100	125	360	360	180	225	65	14	110	125	95	320	250	14	14	267	24	50	27	8	53							
EEP100-80-200						180	250						345	280								76							
EEP100-80-260(H)						225	280						400	315								95							
EEP100-80-320(H)	35	35	35	35	526	250	315	80	16	110	160	120	440	340	18	18	342	32	80	35	10	118							
EEP100-80-320G	45	45	45	45	530	280	355	83	18	110	160	120	440	340	18	18	367	42	110	45	12	130							
EEP100-80-400	25	25	25	25	360	200	250	80	15	110	160	120	360	280	18	18	370	42	110	45	12	160							
EEP125-100-160	35	100	125	360	360	200	250	80	16	110	160	150	500	400	23	23	370	42	110	45	12	87							
EEP125-100-200						200	280						400	315								18	18	342	32	80	35	10	102
EEP125-100-260(H)						225	280						400	315								18	18	342	32	80	35	10	118
EEP125-100-320	45	45	45	45	530	280	355	100	20	110	200	150	500	400	23	23	370	42	110	45	12	176							
EEP125-100-400	35	35	35	35	470	250	315	80	16	110	160	120	400	315	18	18	342	32	80	35	10	117							
EEP150-125-200	45	125	150	360	360	315	400	100	18	110	200	150	500	400	23	23	370	42	110	45	12	155							
EEP150-125-260						315	400						400	315								18	18	342	32	80	35	10	178
EEP150-125-320						355	450						500	400								25	25	370	42	110	45	12	300
EEP150-125-400	55	55	55	55	555	280	400	100	18	110	200	150	400	315	23	23	342	32	80	35	10	132							
EEP200-150-200	35	150	200	360	360	250	355	100	18	110	200	150	450	350	23	23	370	42	110	45	12	163							
EEP200-150-260						280	400						400	315								18	18	342	32	80	35	10	170
EEP200-150-320						315	450						450	315								22	22	370	42	110	45	12	207
EEP200-150-400	45	45	45	45	670	375	500	100	22	110	200	150	550	450	28	28	370	42	110	45	12	330							
EEP250-200-260	45	200	250	360	360	555	315	100	18	110	200	150	550	450	23	23	370	42	110	45	12	219							
EEP250-200-320						555	450						400	315								20	20	392	42	45	12	286	
EEP250-200-400						670	375						500	400								120	32	505	48	51	14	328	
EEP250-200-500	55	55	55	55	720	425	560	100	22	140	200	150	660	560	23	19	515	60	140	64	18	450							
EEP300-250-320	55	250	300	360	360	691	355	150	26	110	250	200	660	510	28	14	370	42	110	51	14	366							
EEP300-250-400						682	400						560	400								32	32	516	48	110	51	14	396
EEP300-250-500						720	450						670	120								32	32	516	48	110	51	14	550
EEP350-300-400	65	250	300	200	720	425	670	120	30	140	240	190	750	650	23	19	515	60	140	64	18	550							
EEP350-300-500	65	300	350	300	720	425	670	120	30	140	250	190	760	660	30	19	515	60	140	64	18	550							

(ISO7005.2 DIN2501 PN16 GB/T17241.6 PN1.6)

DN1/DN2	32	40	50	65	80	100	125	150	200	250	300	350	400
D1/D2	140	150	165	185	200	220	250	285	340	405	460	520	580
K1/K2	100	110	125	145	160	180	210	240	295	355	410	470	525
n-d1/n-d2	4-φ18	4-φ18	4-φ18	4-φ18	8-φ18	8-φ18	8-φ18	8-φ22	12-φ22	12-φ26	12-φ26	16-φ26	16-φ30

Installation Dimensions

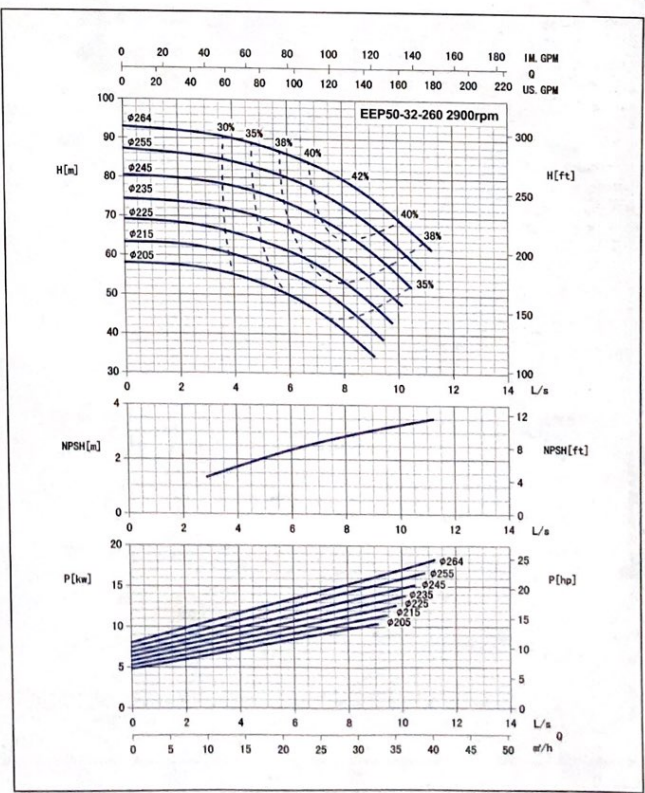
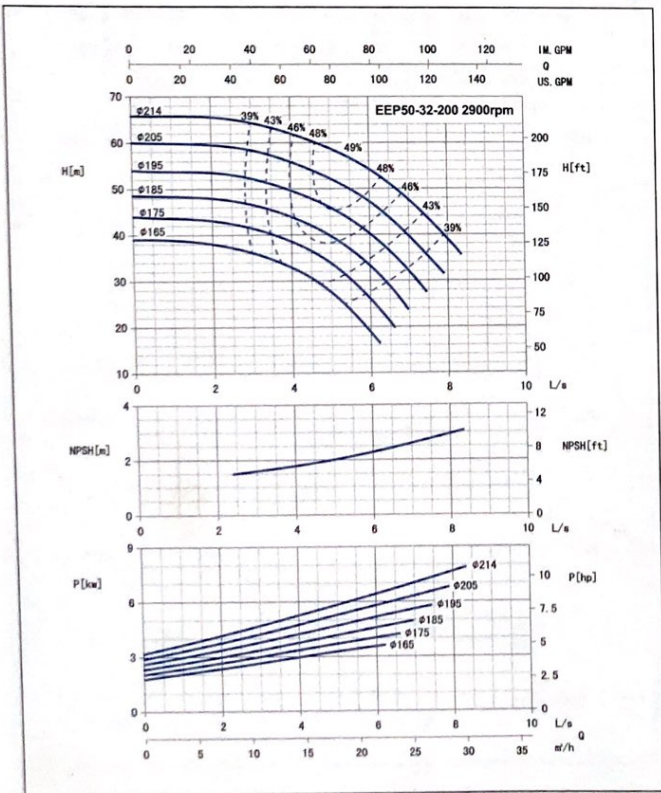
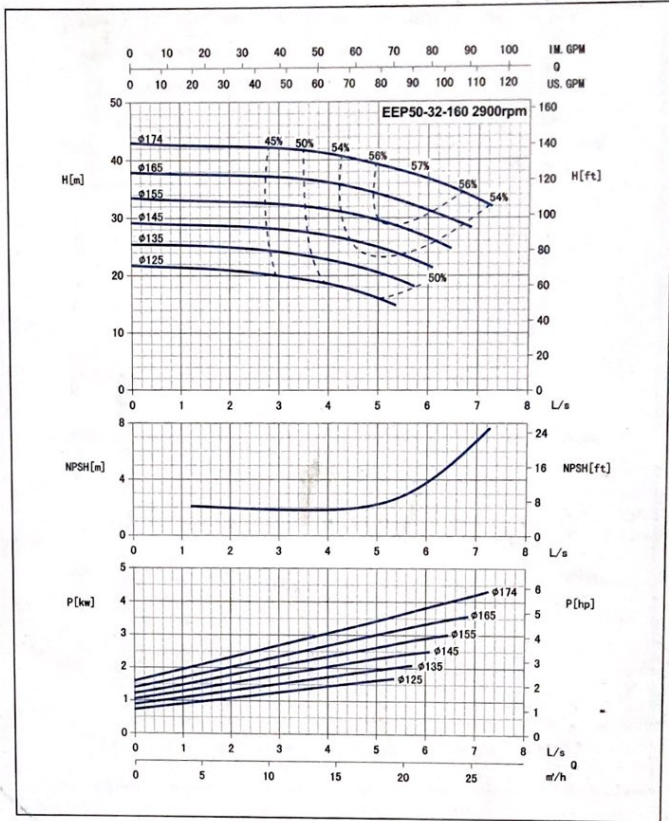
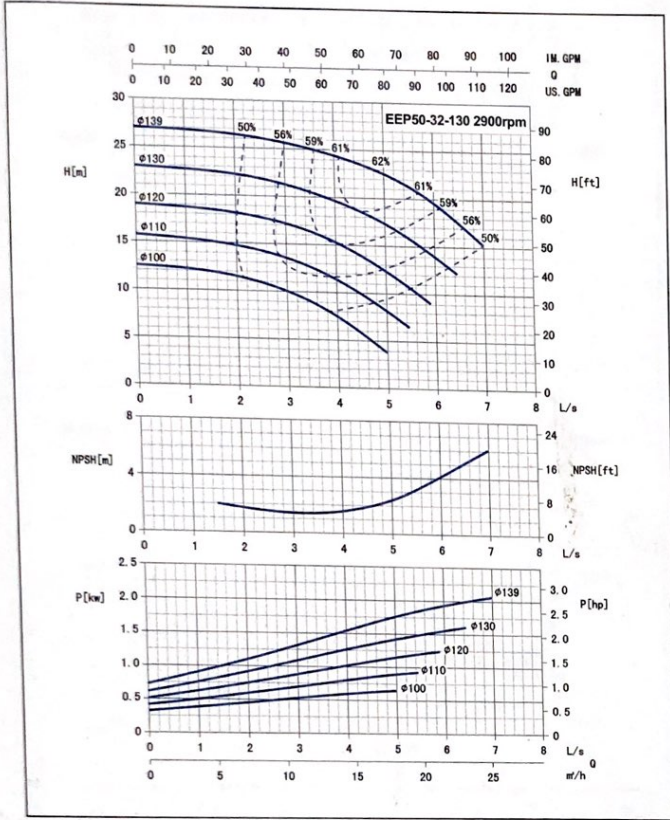

End Suction Centrifugal Pump

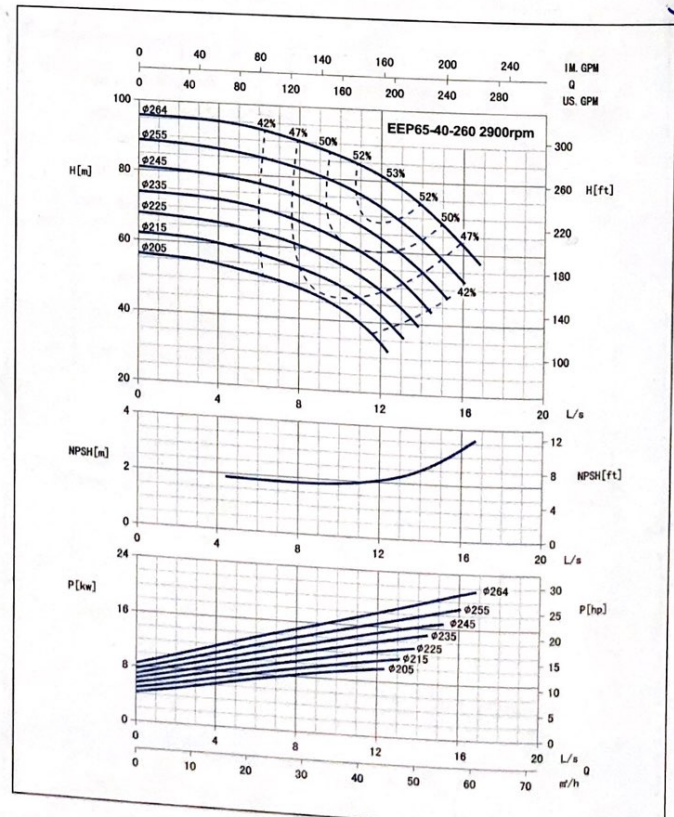
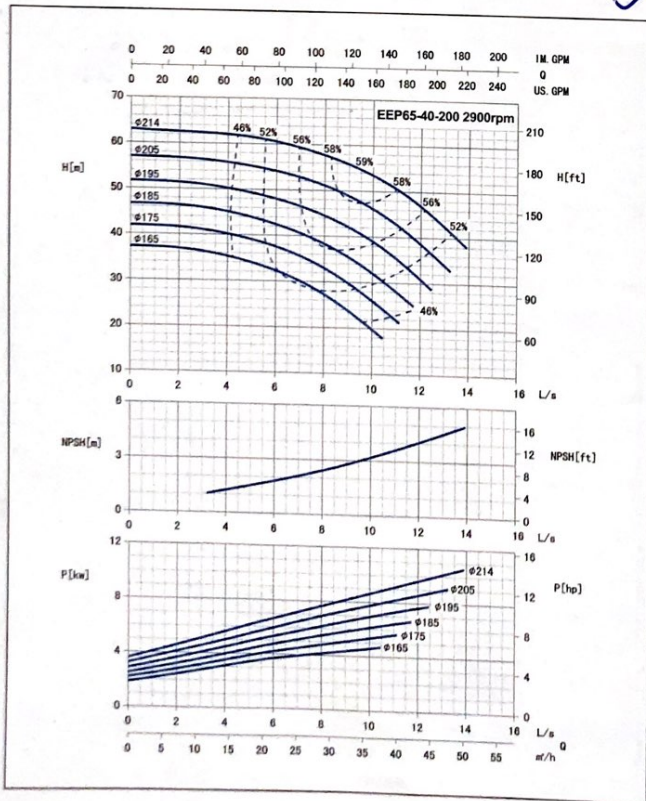
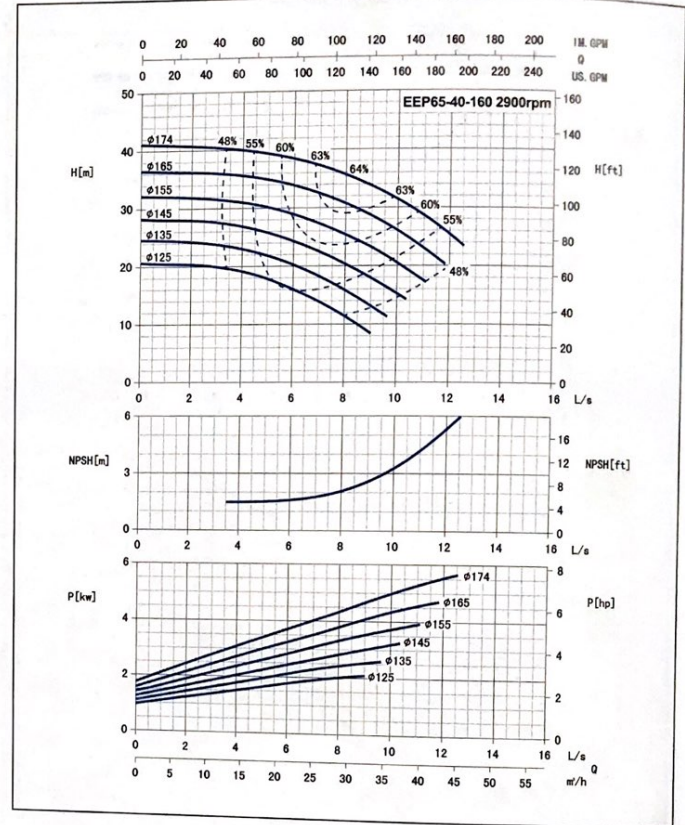
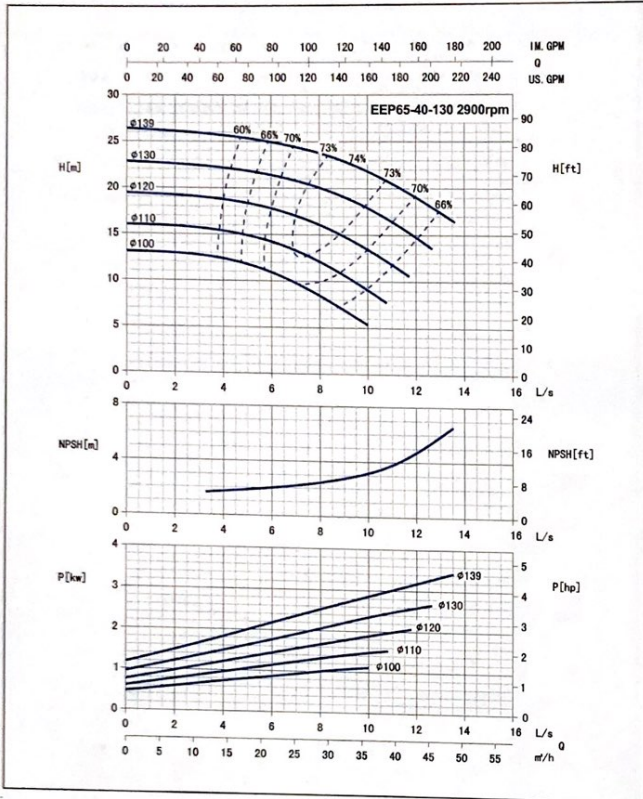

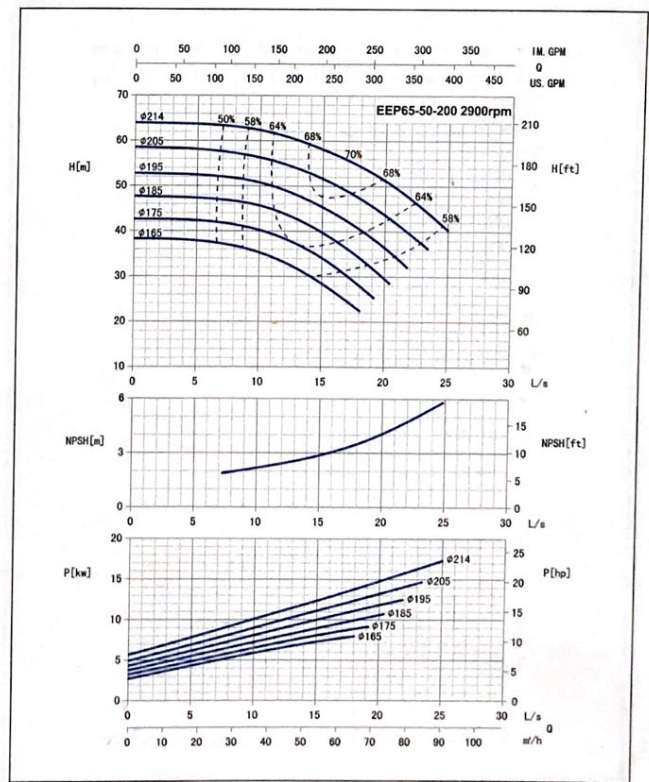
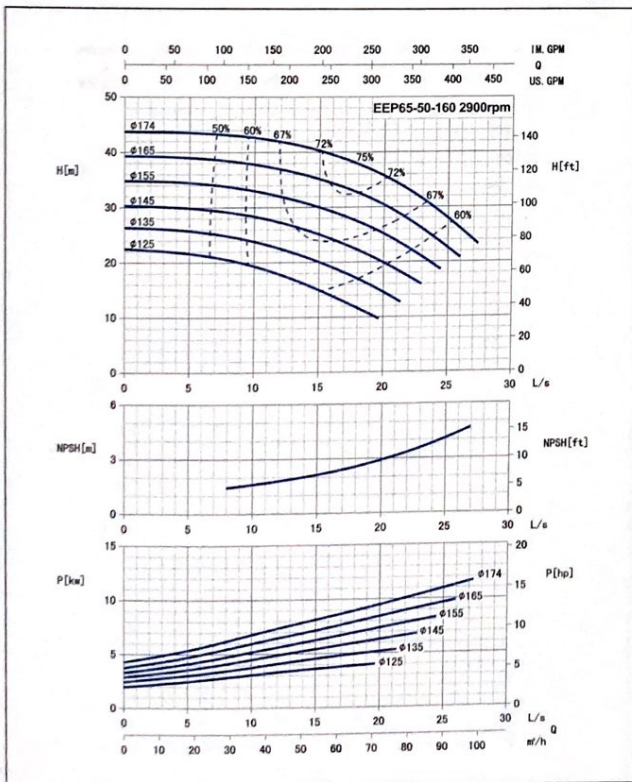
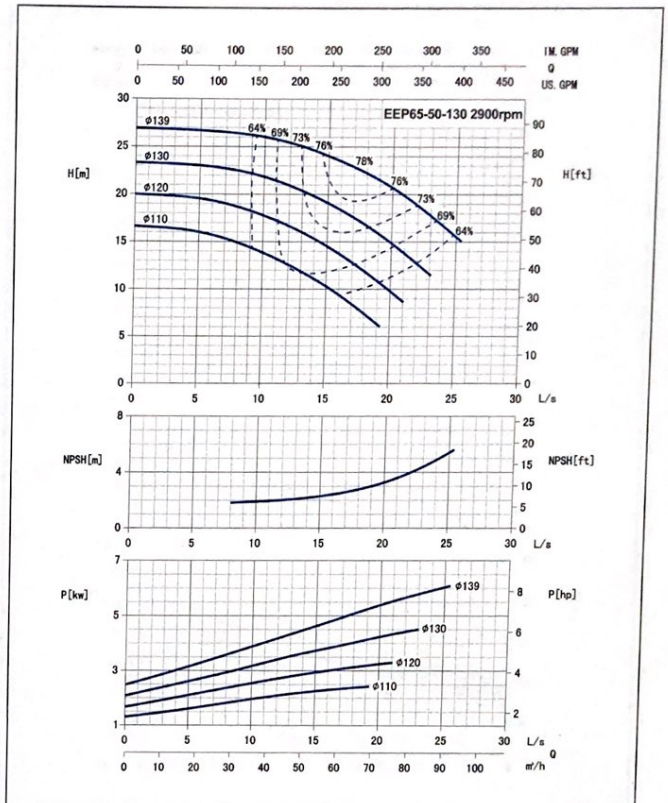
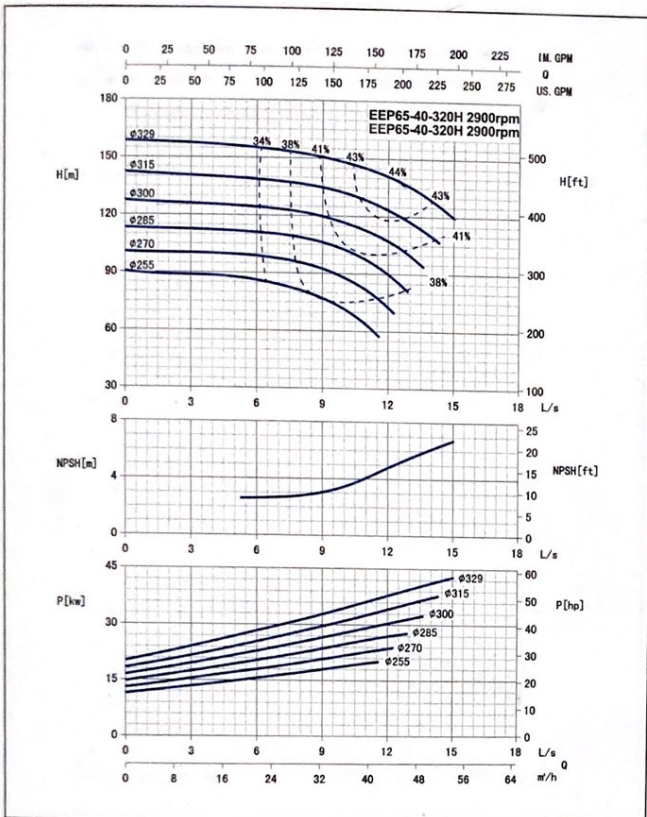

End Suction Centrifugal Pump

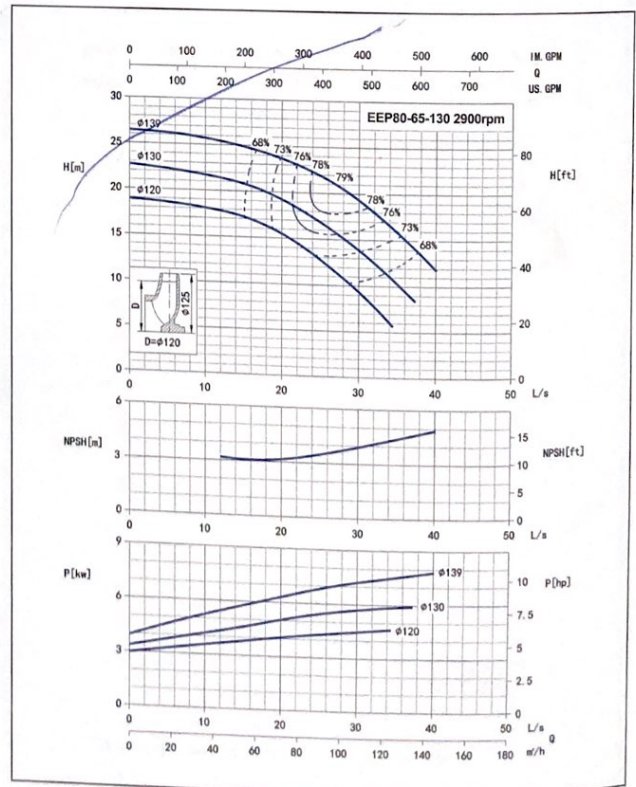
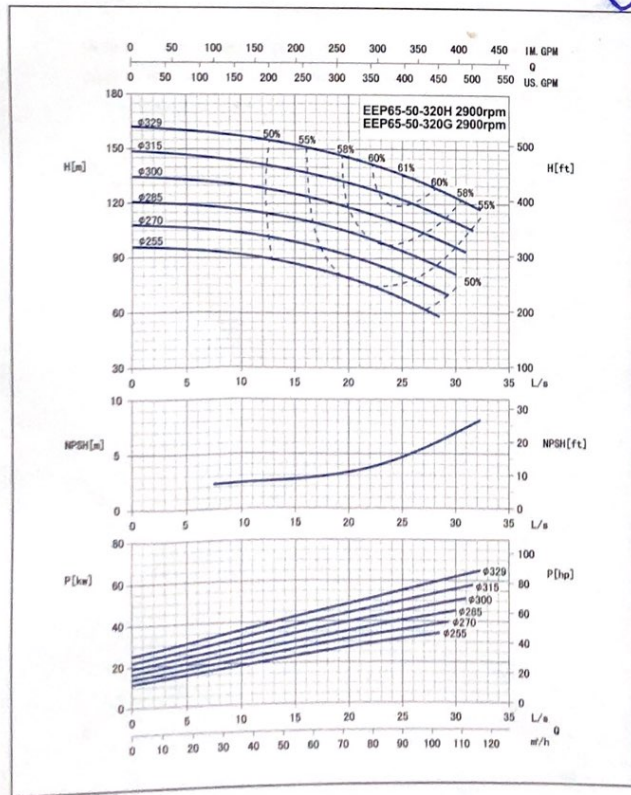
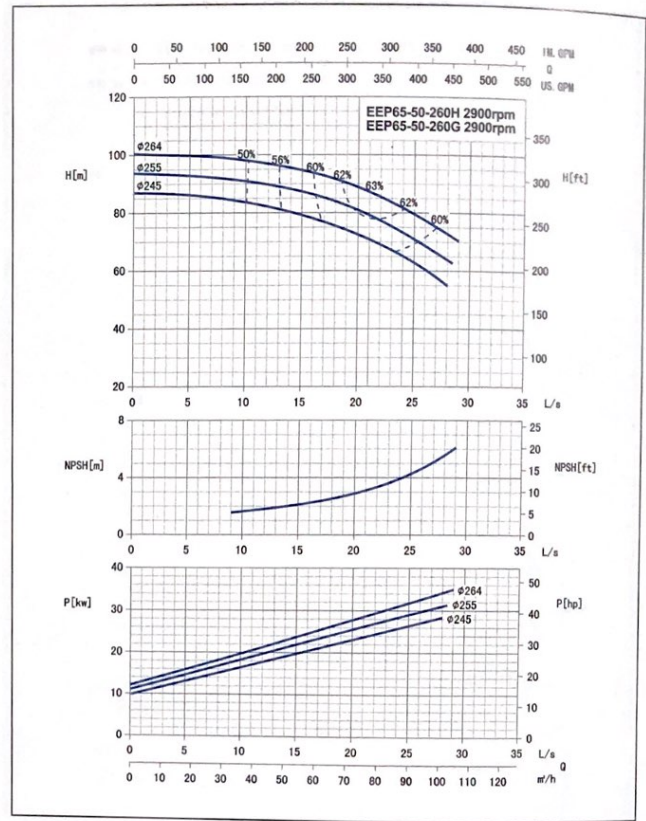
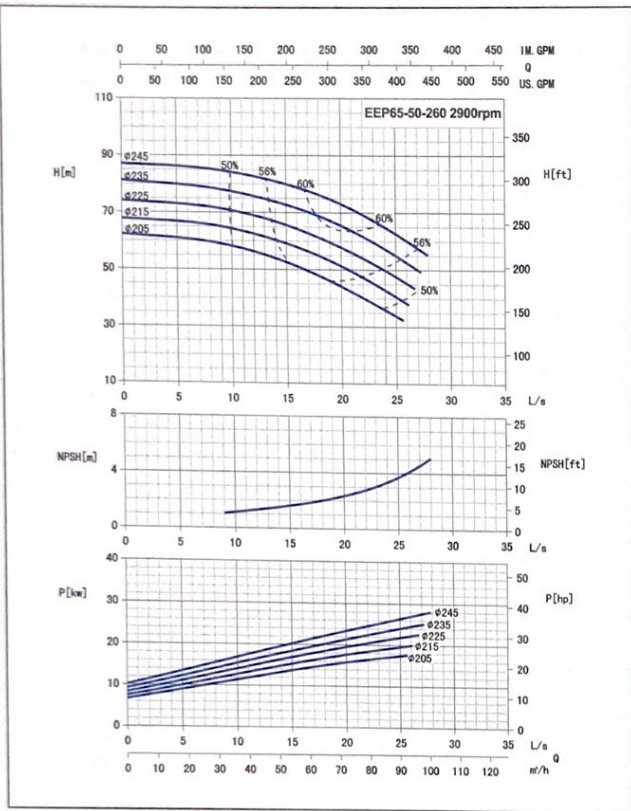

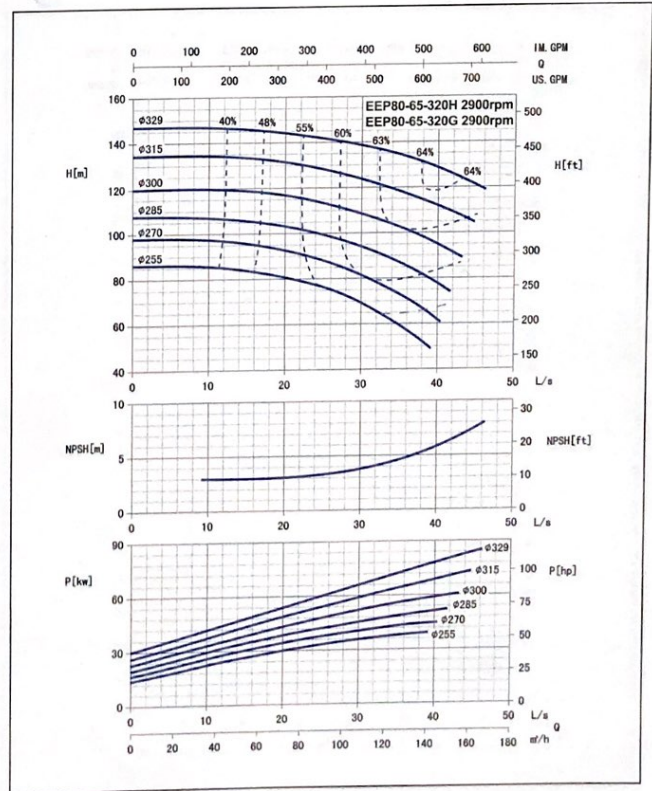
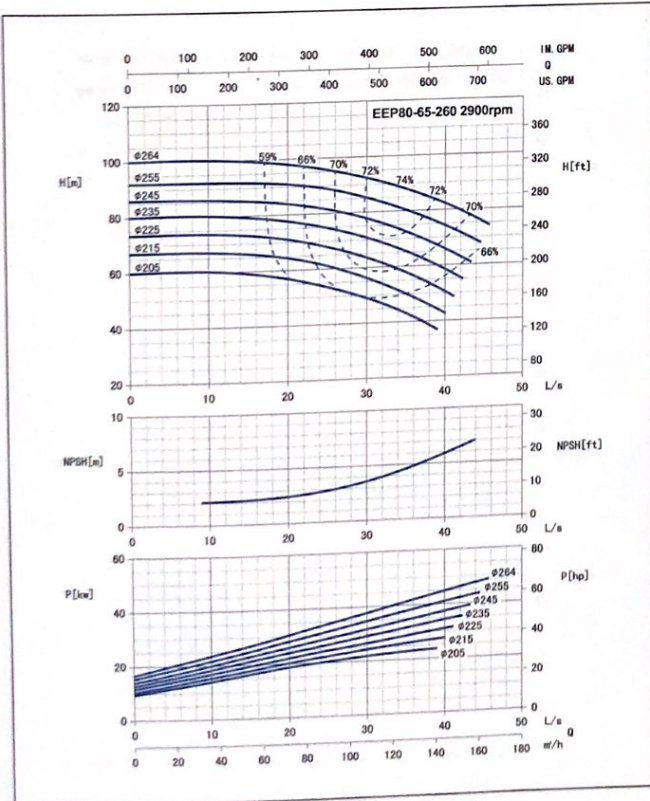
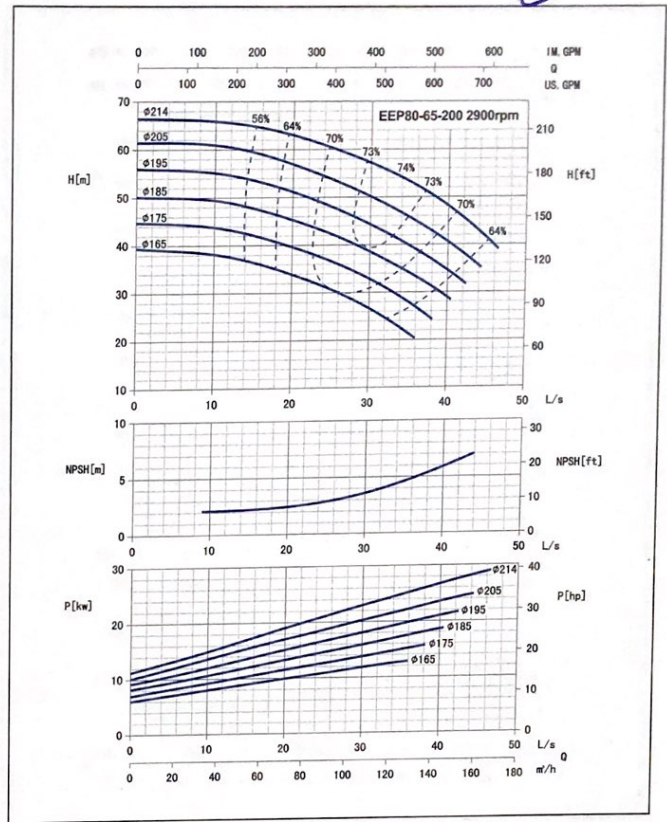
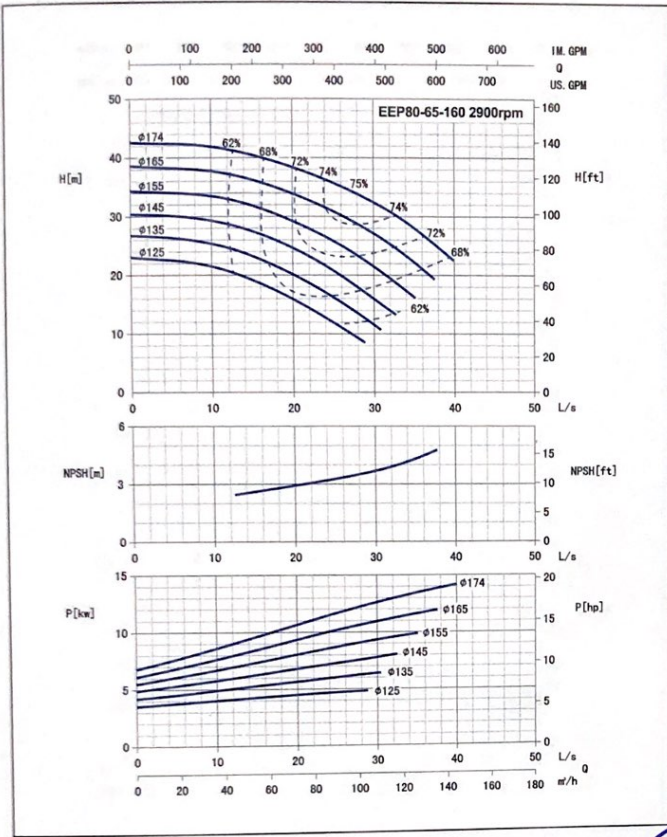

End Suction Centrifugal Pump

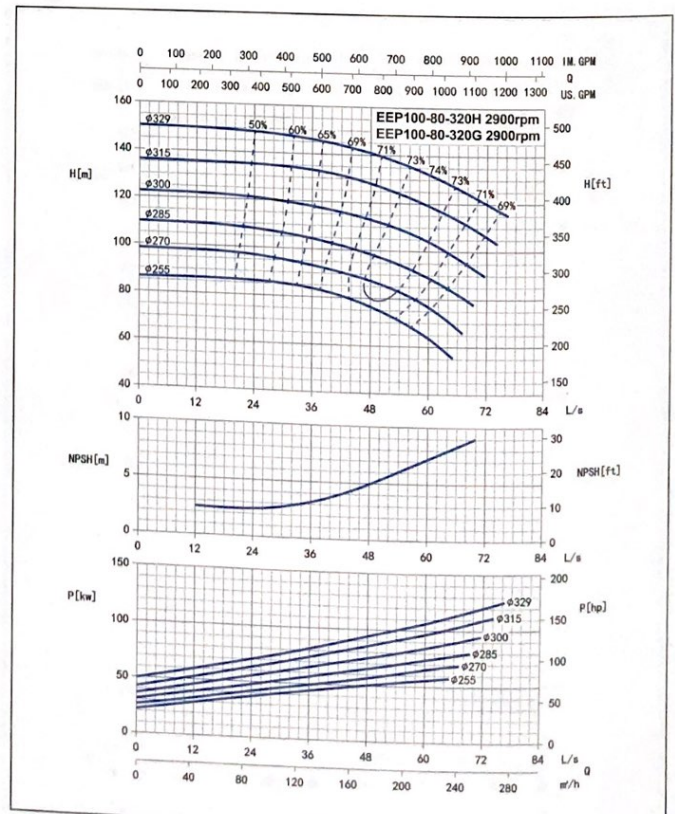
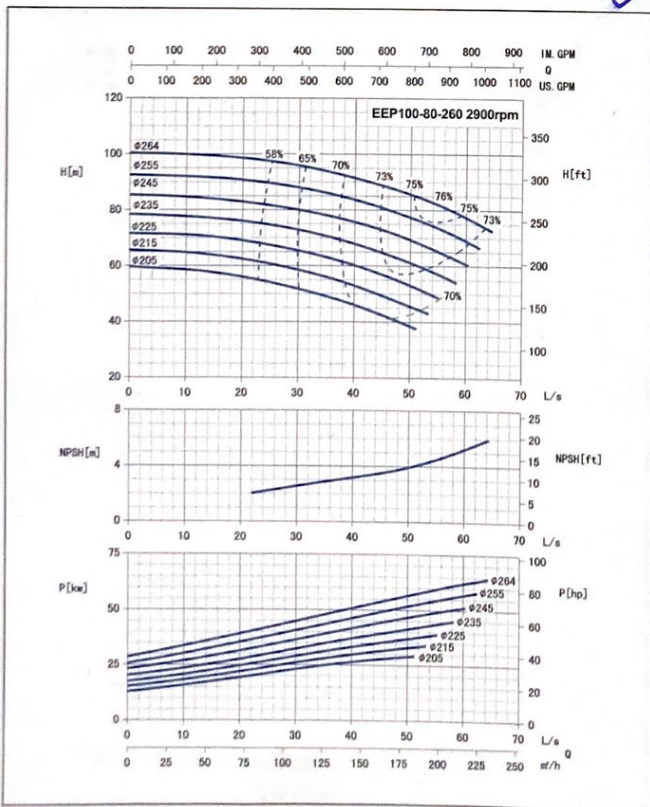
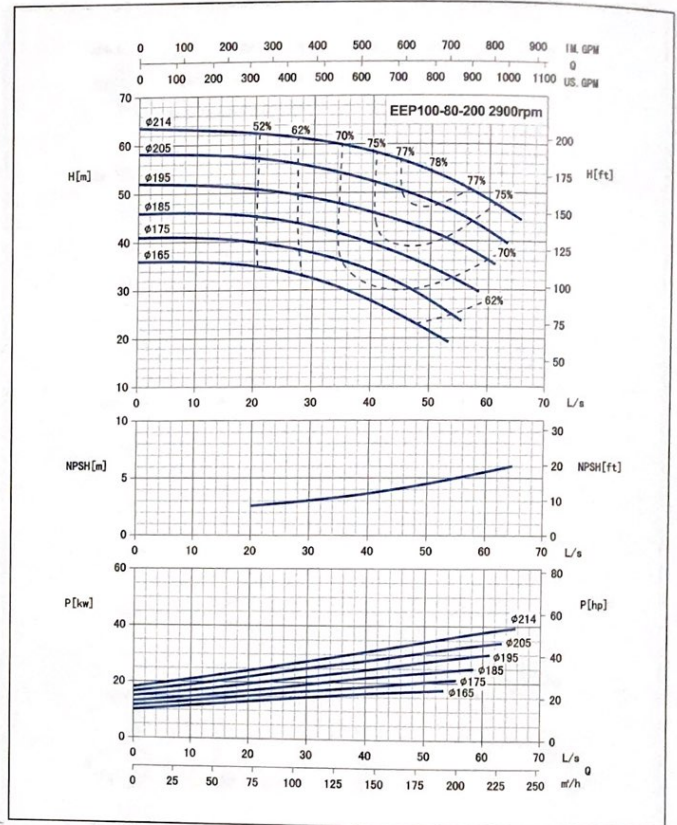
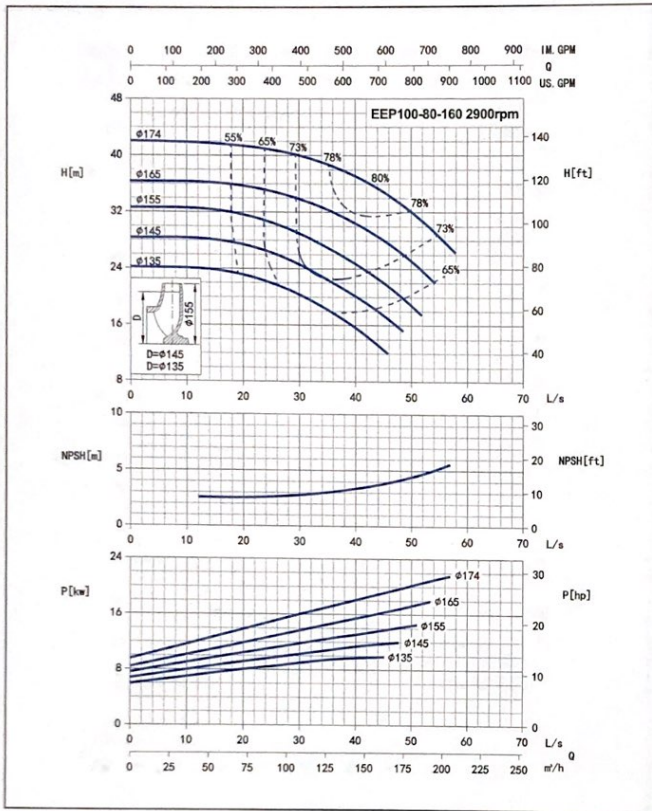

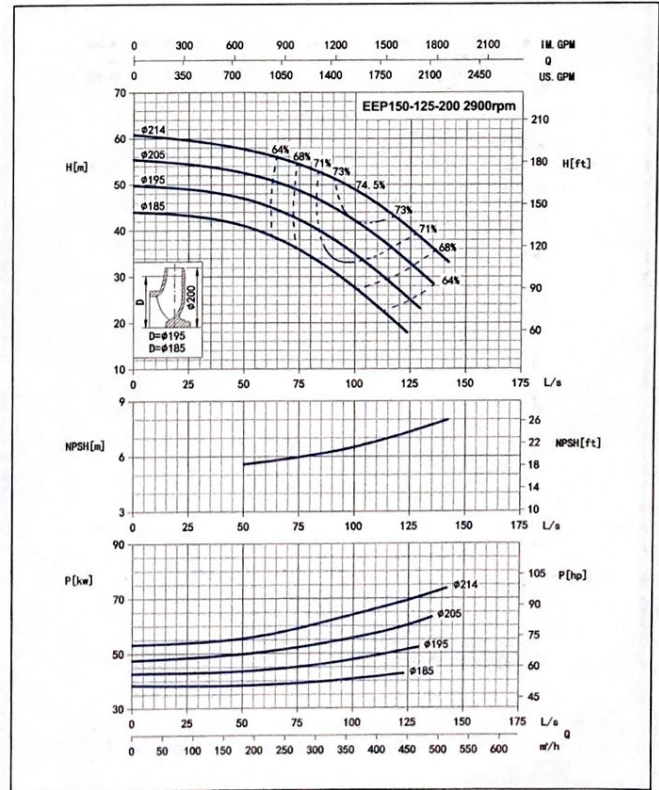
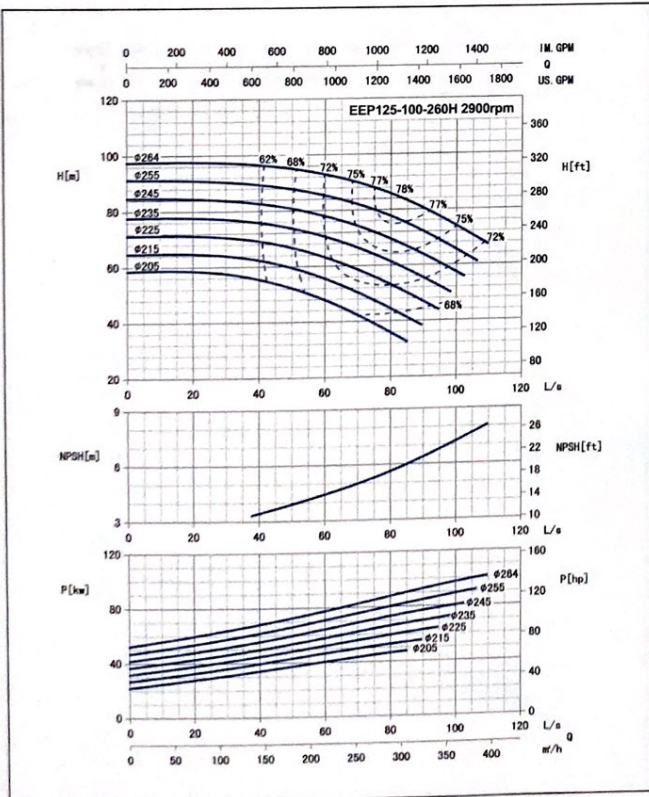
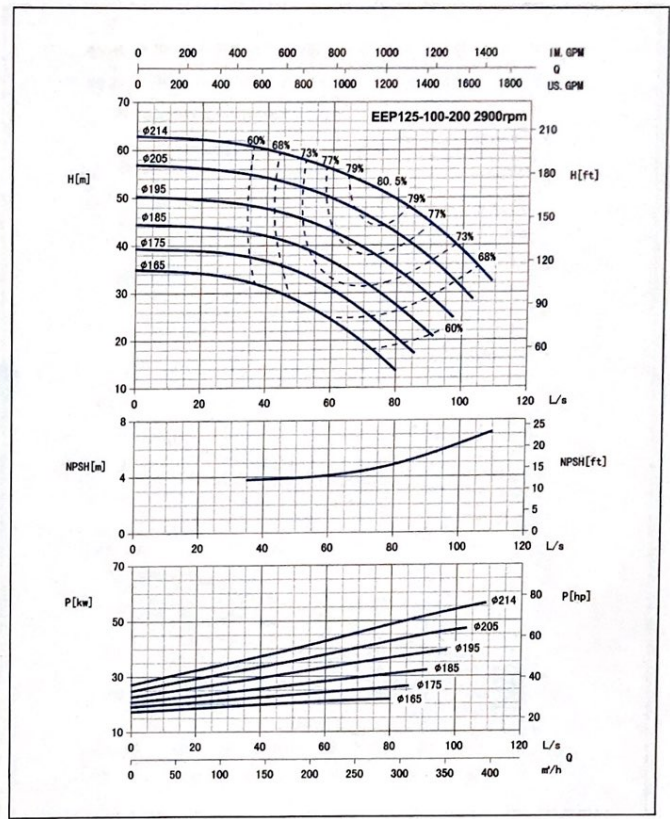
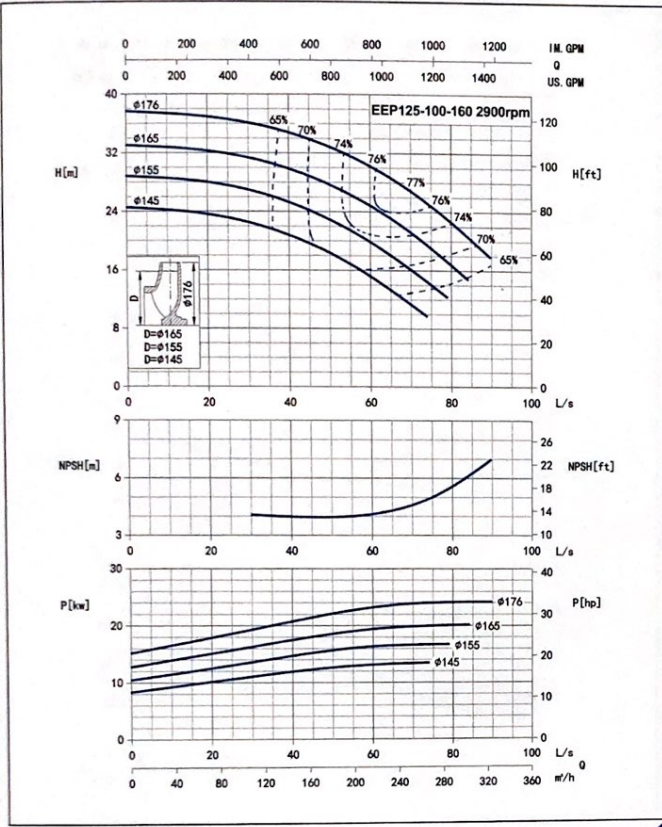

End Suction Centrifugal Pump

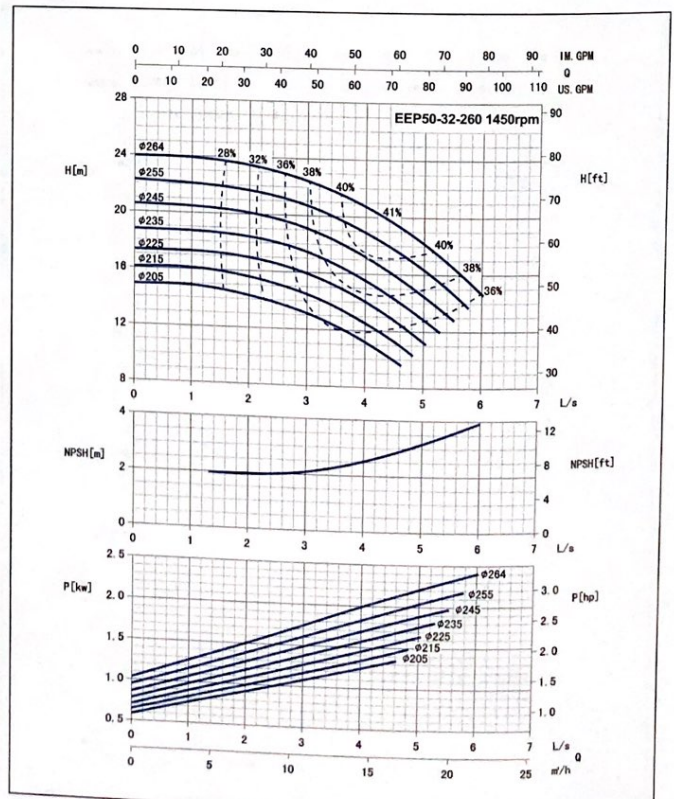
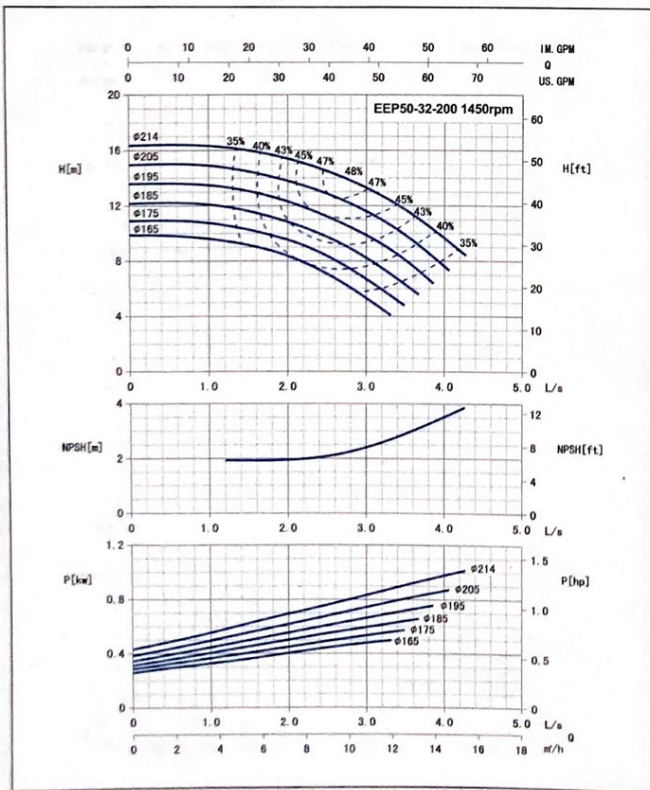
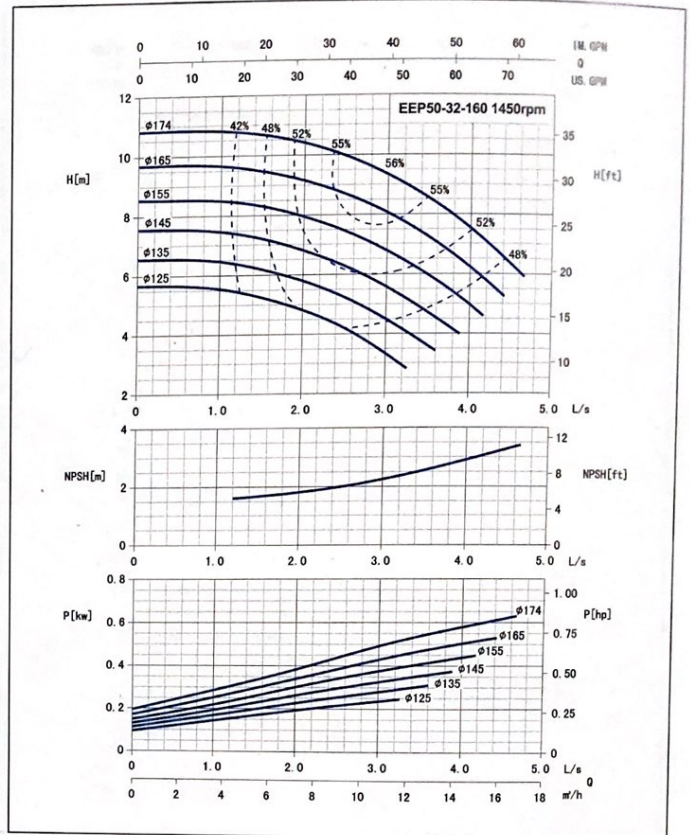
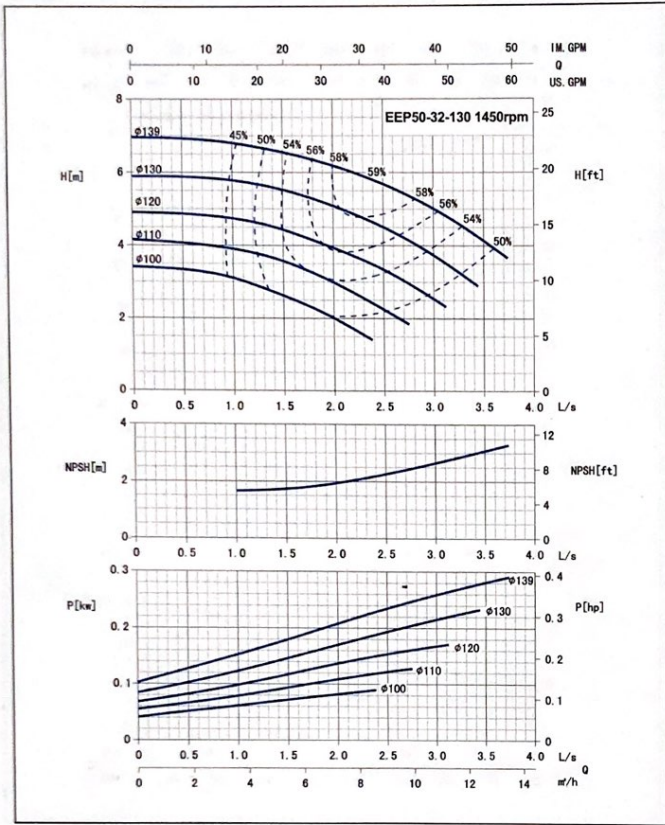

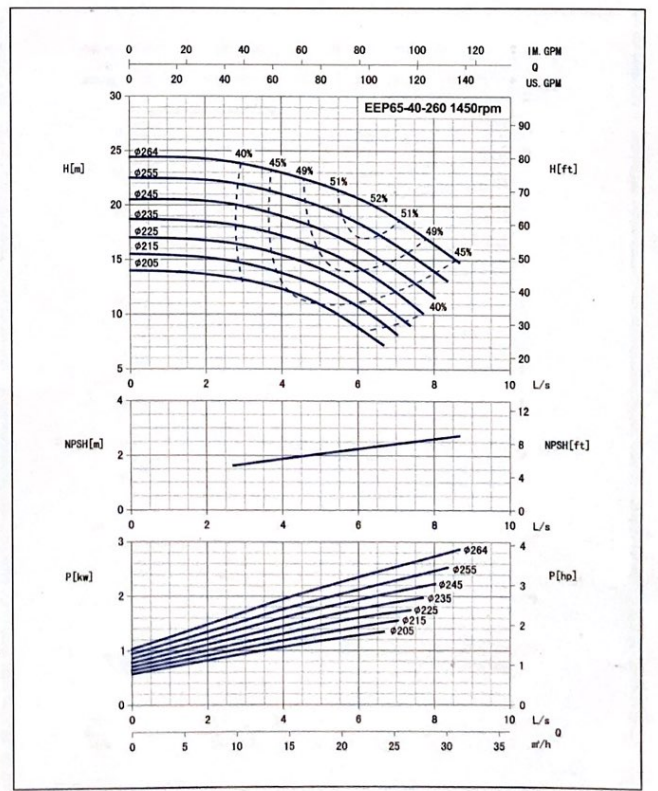
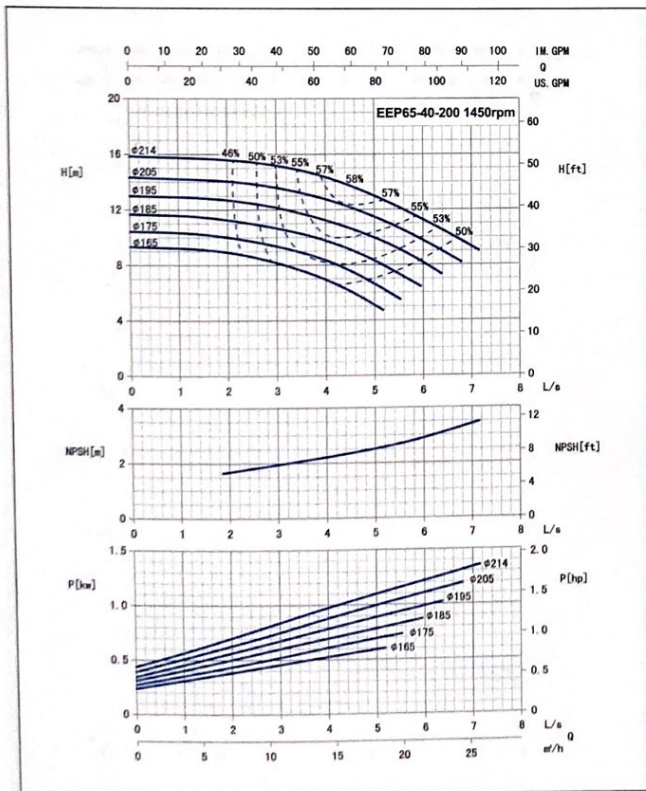
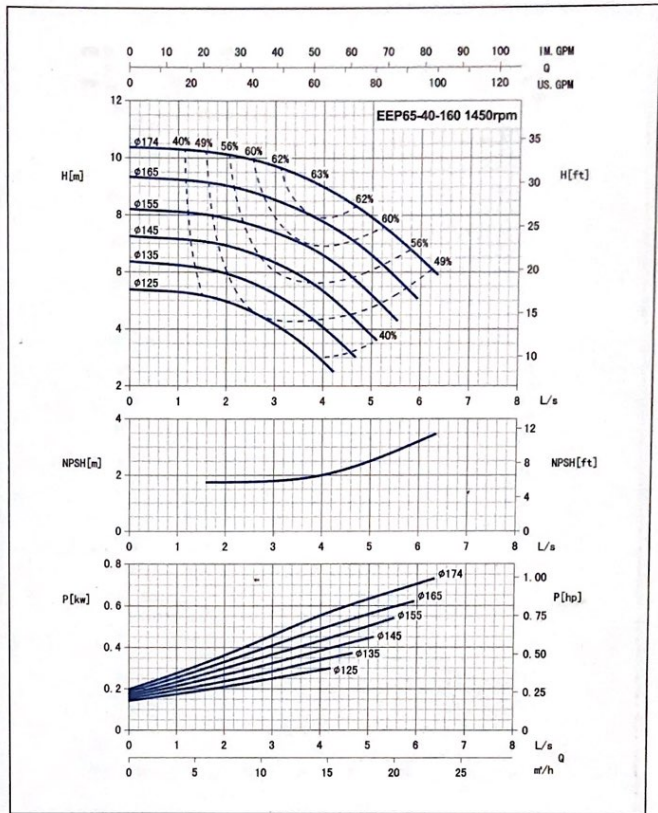
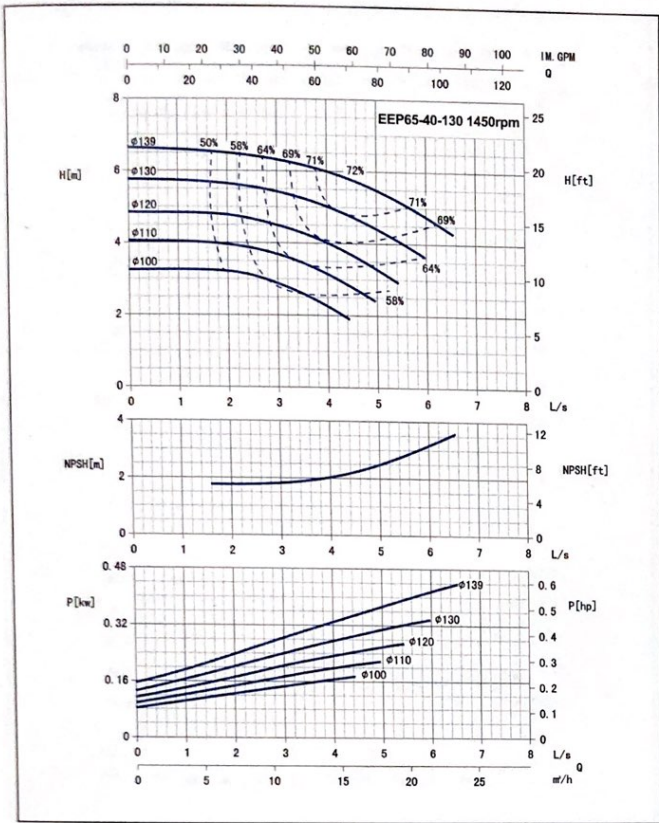

End Suction Centrifugal Pump

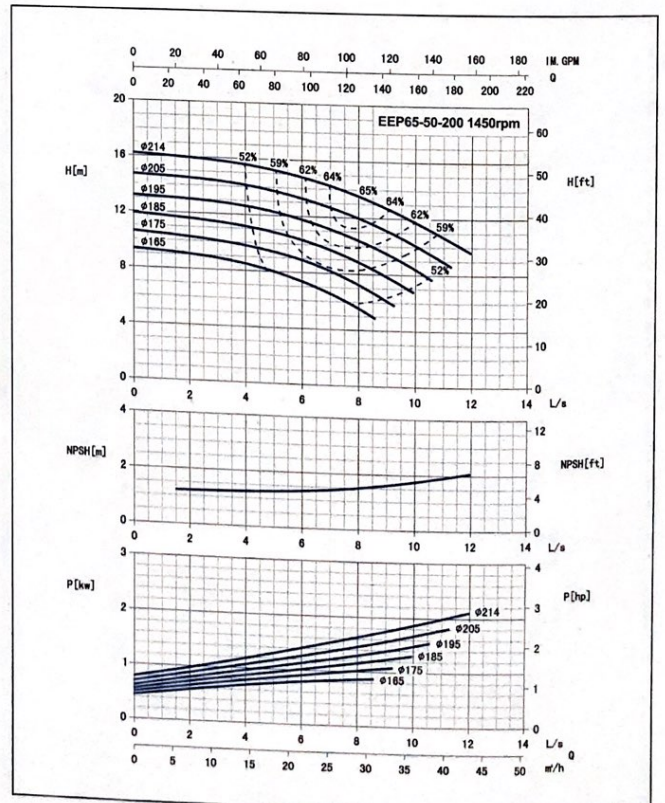
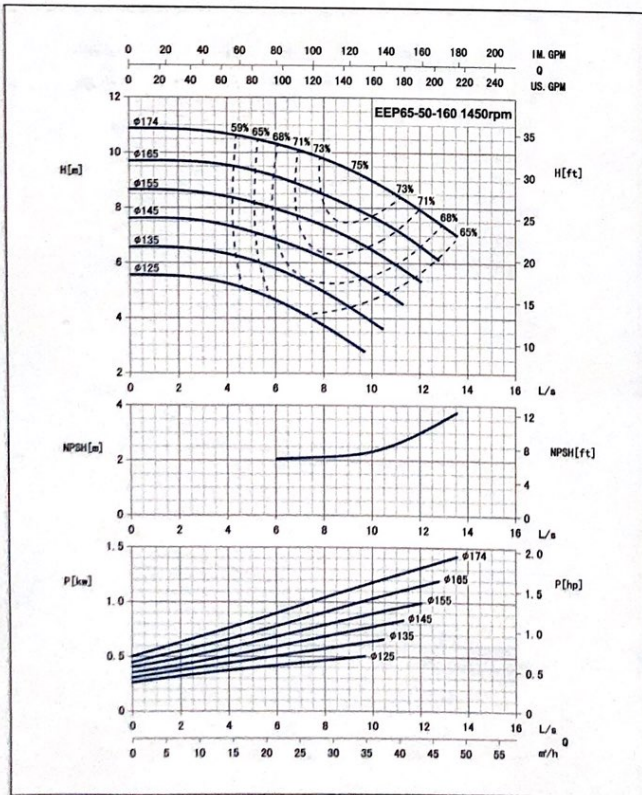
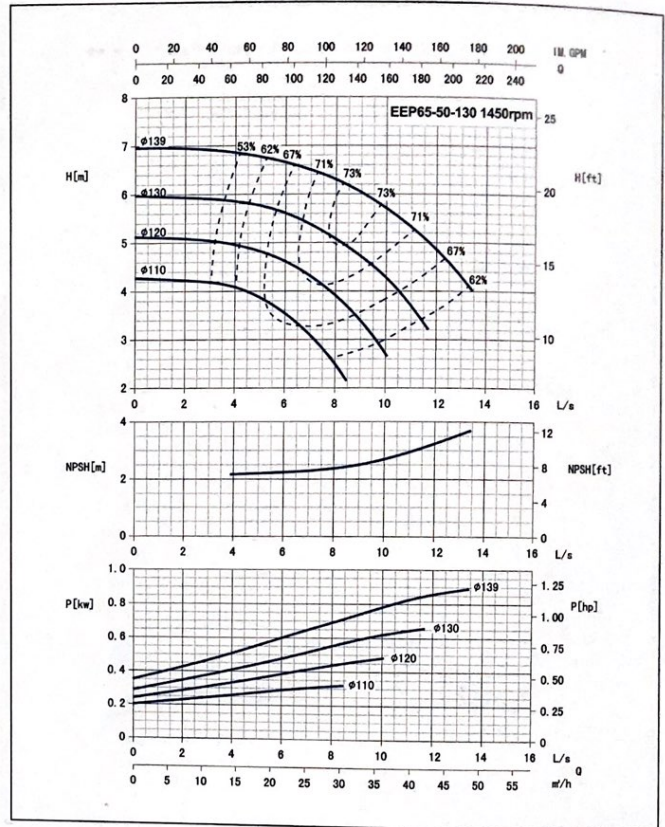
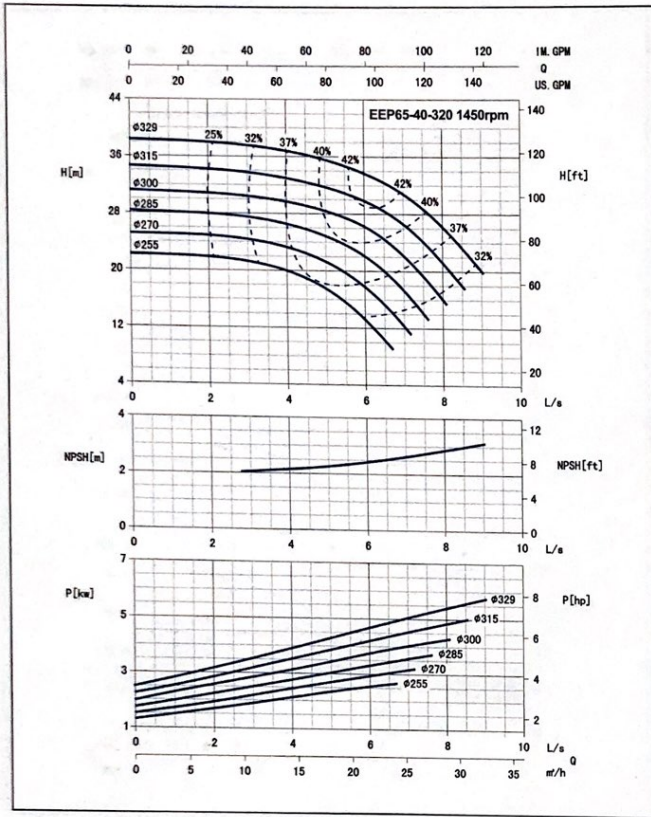

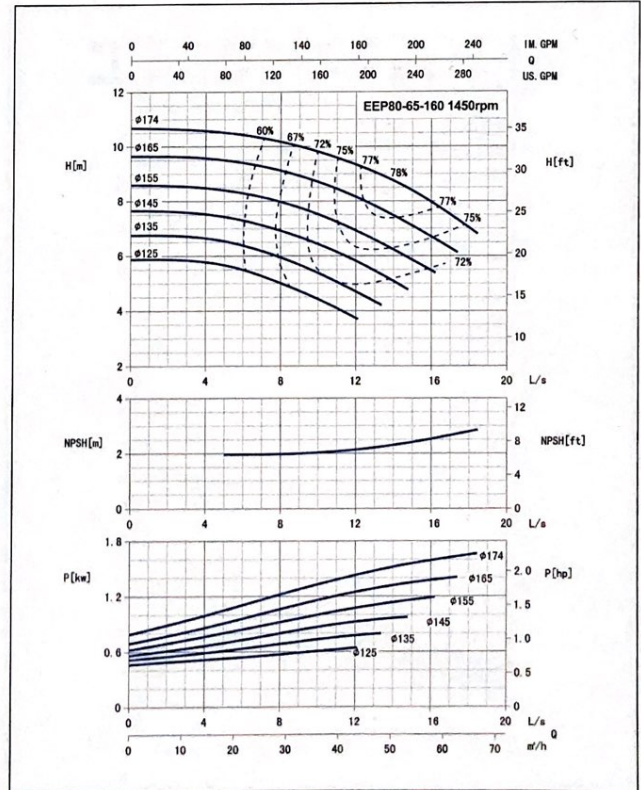
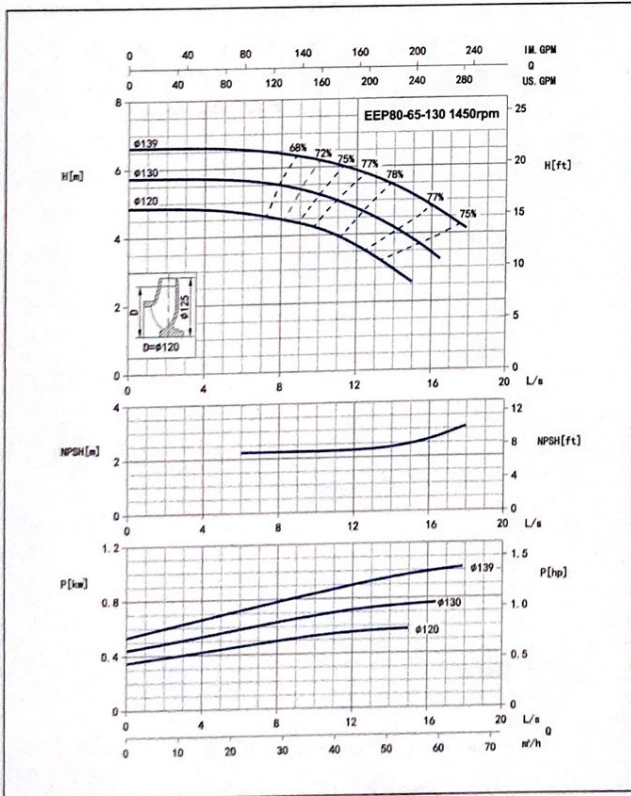
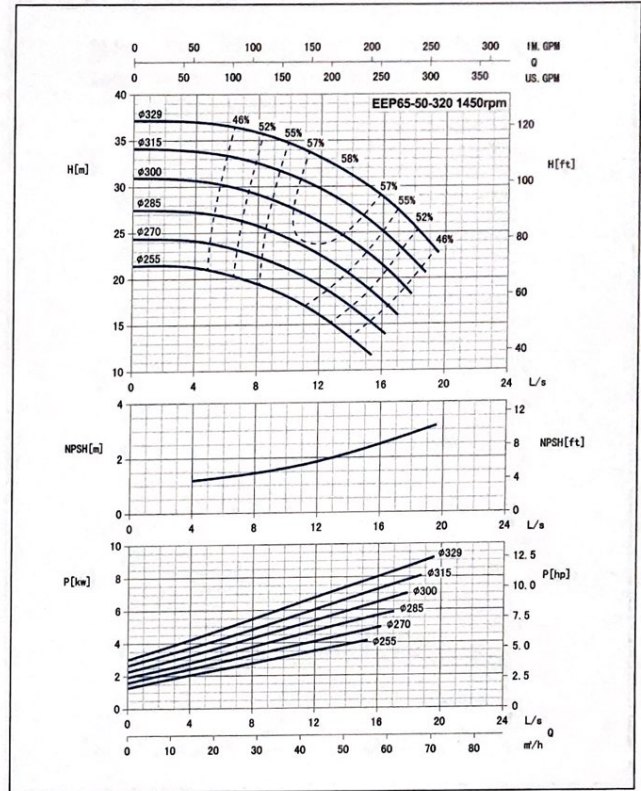
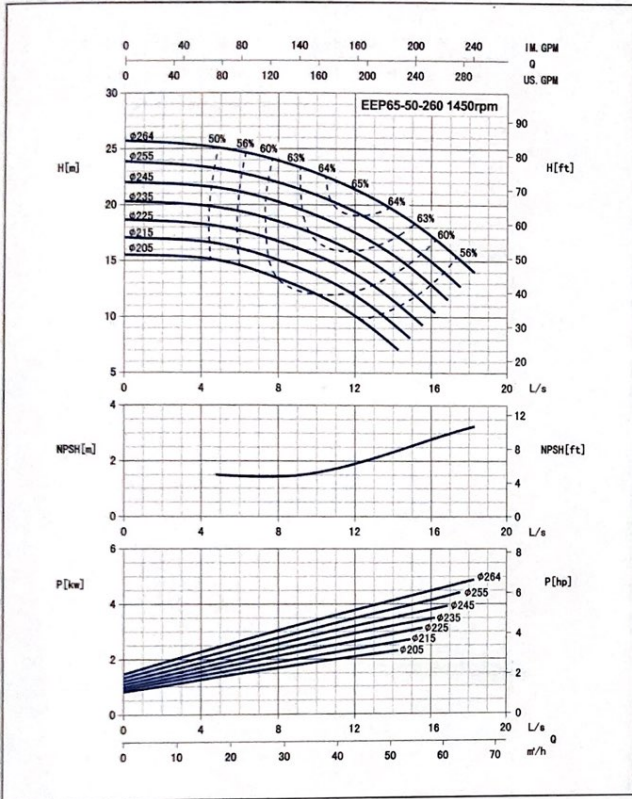

End Suction Centrifugal Pump

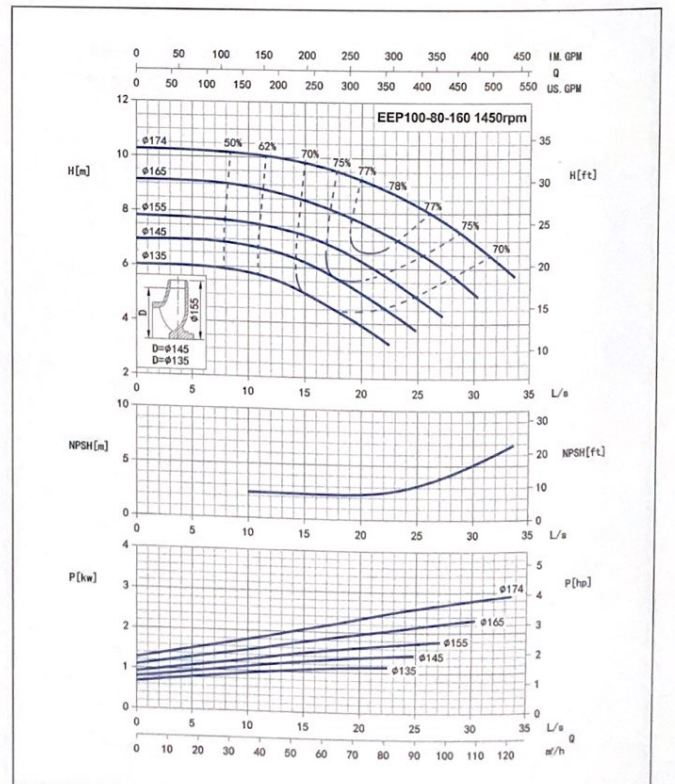
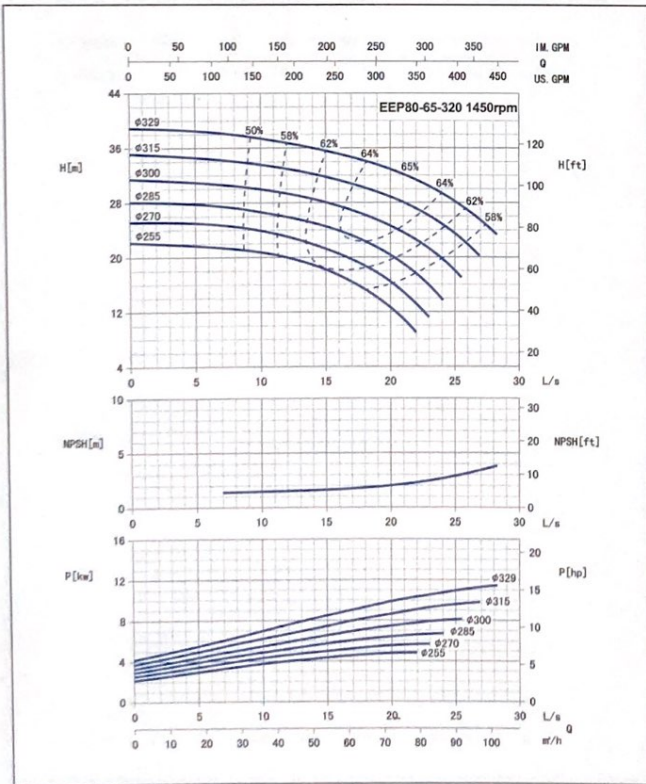
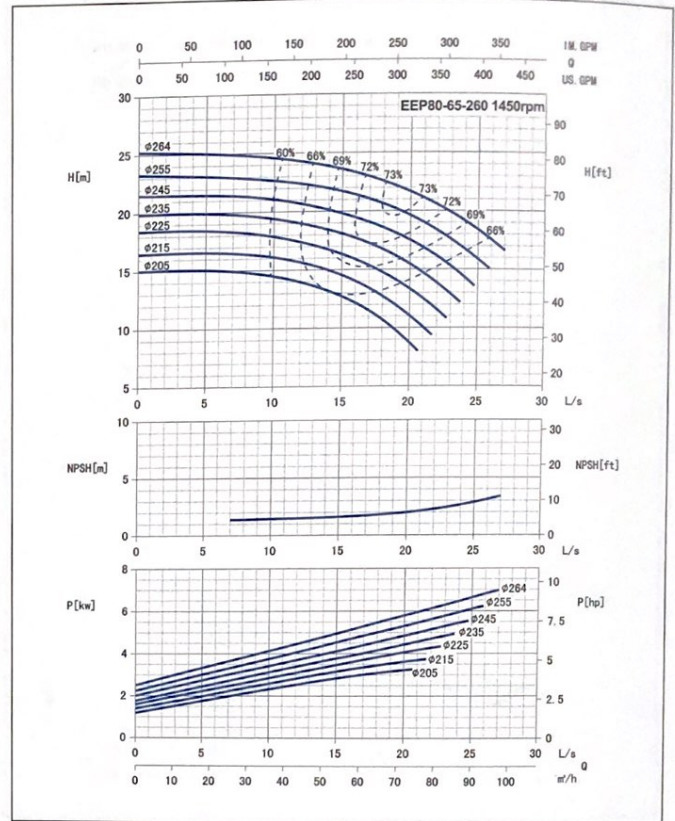
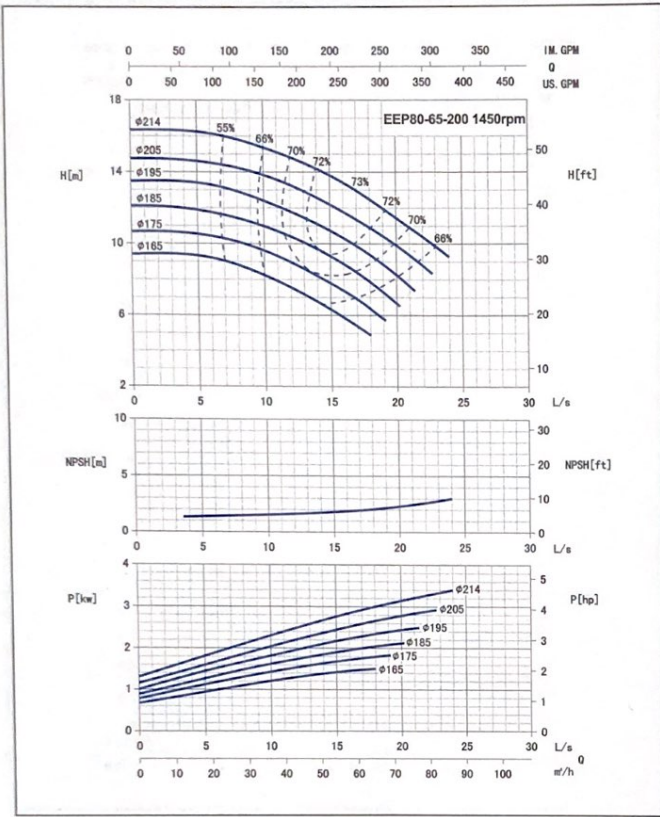

End Suction Centrifugal Pump

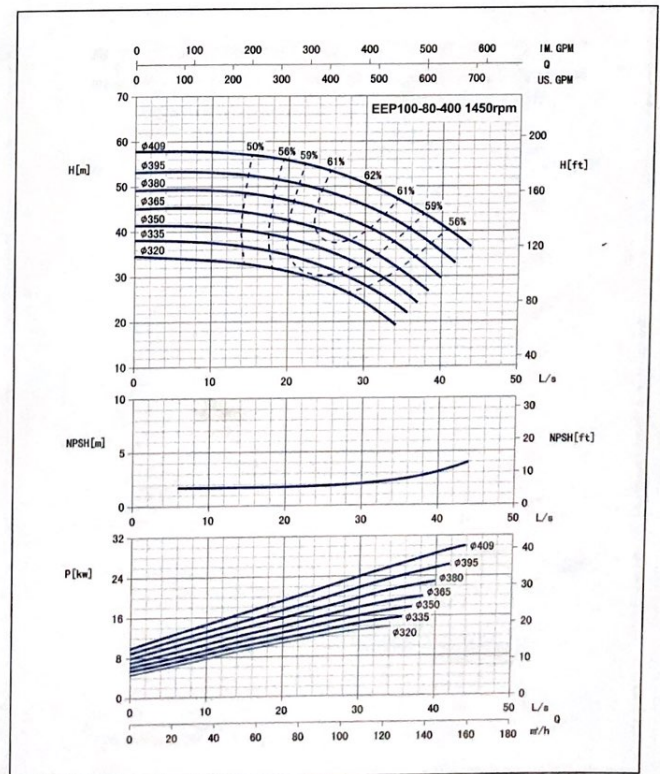
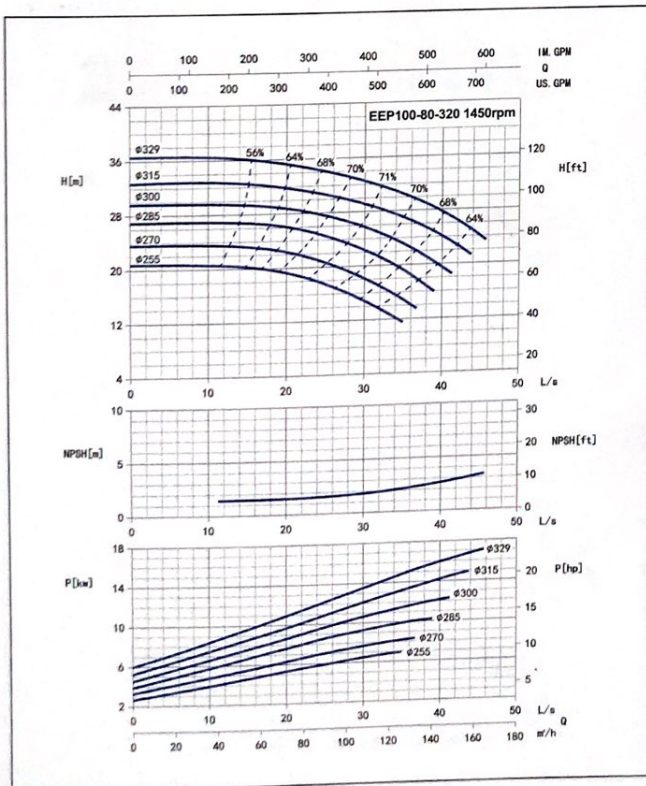
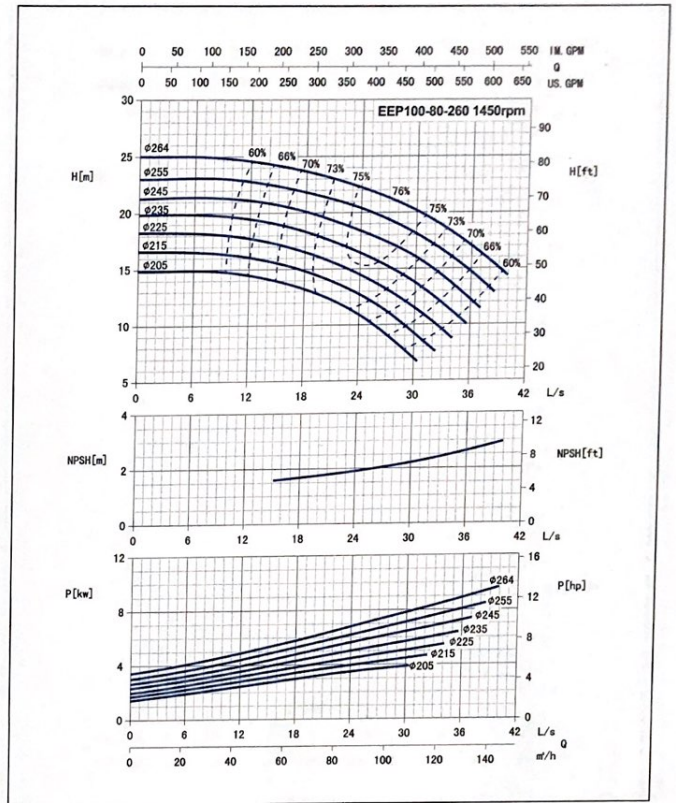
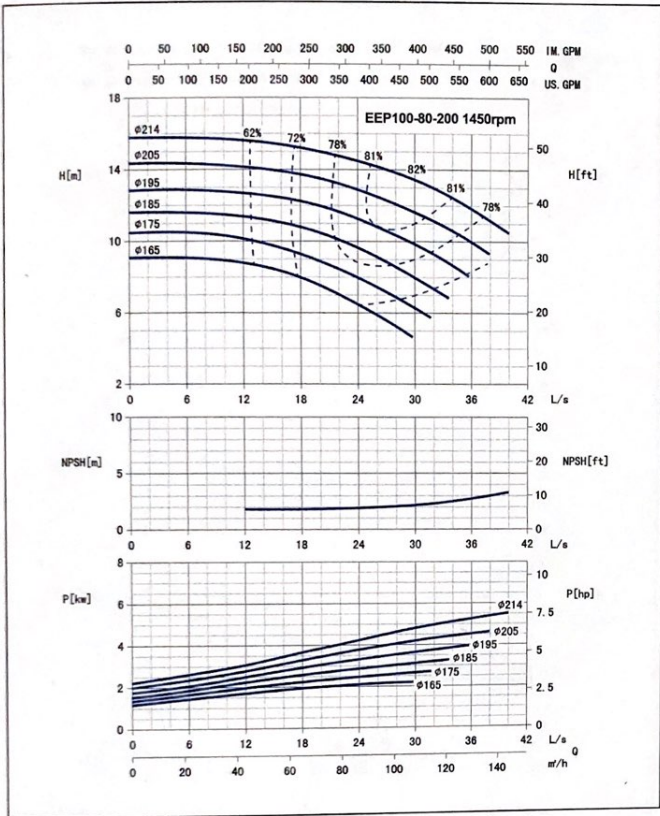

End Suction Centrifugal Pump

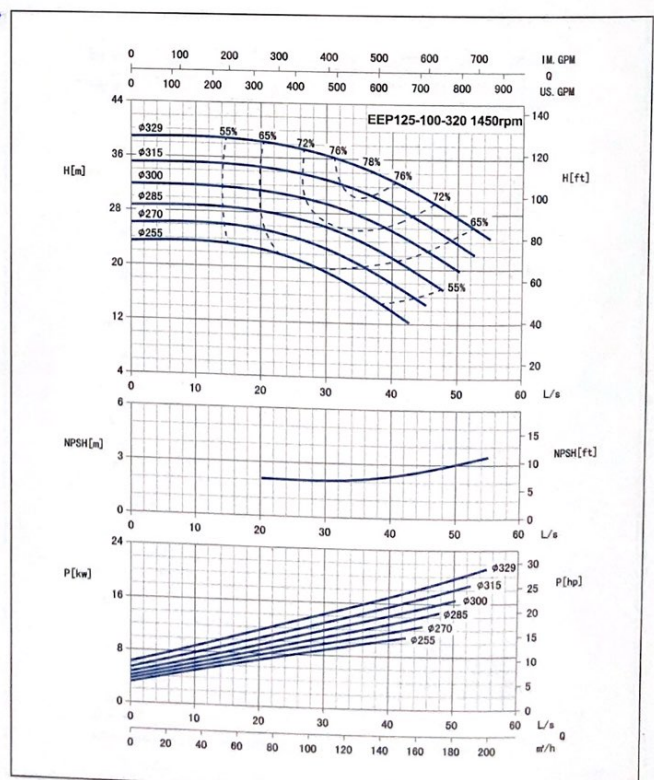
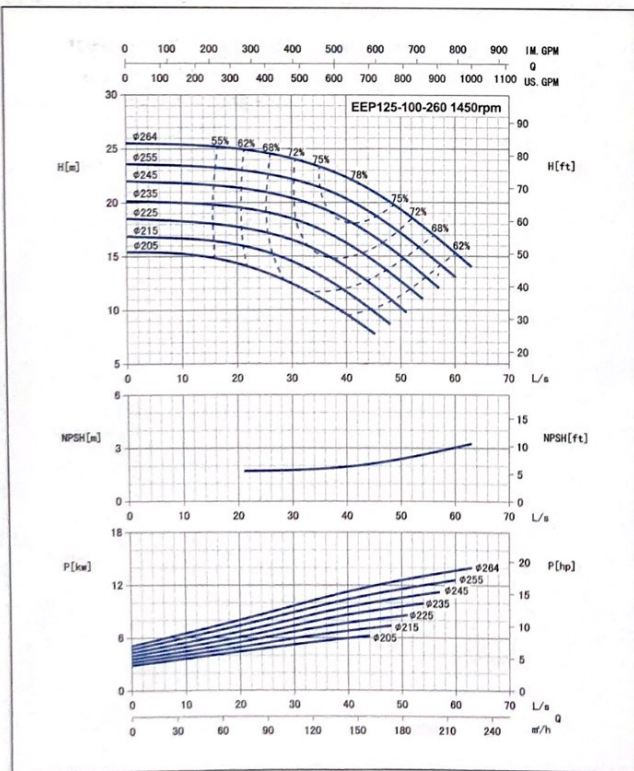
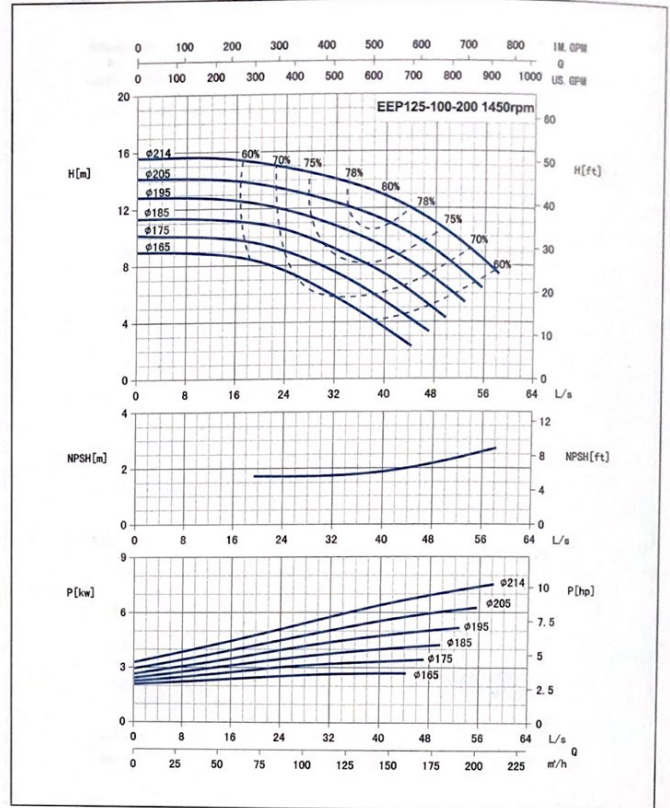
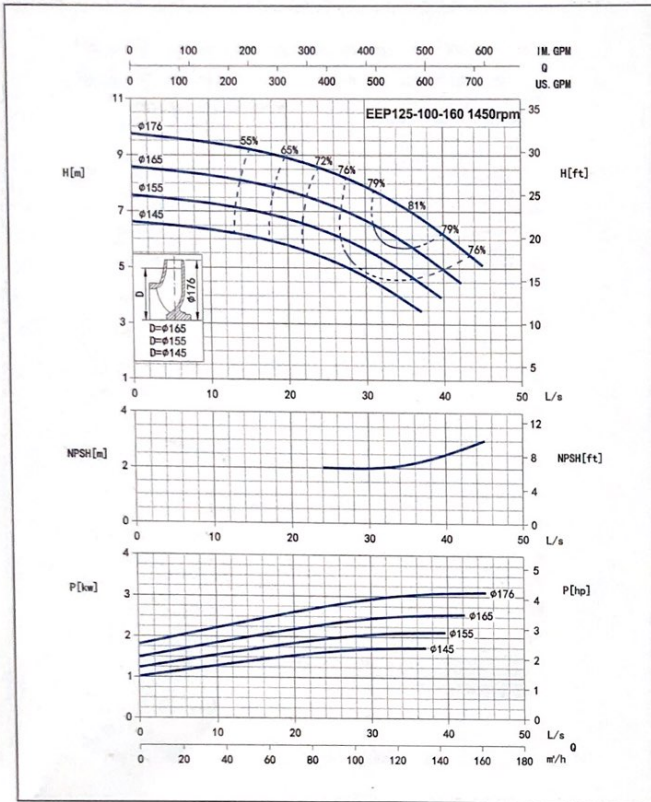

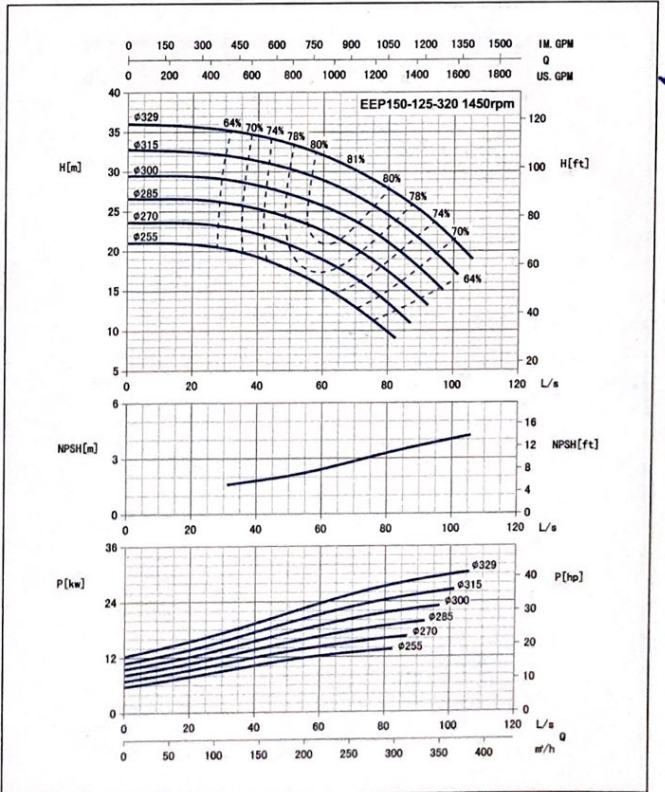
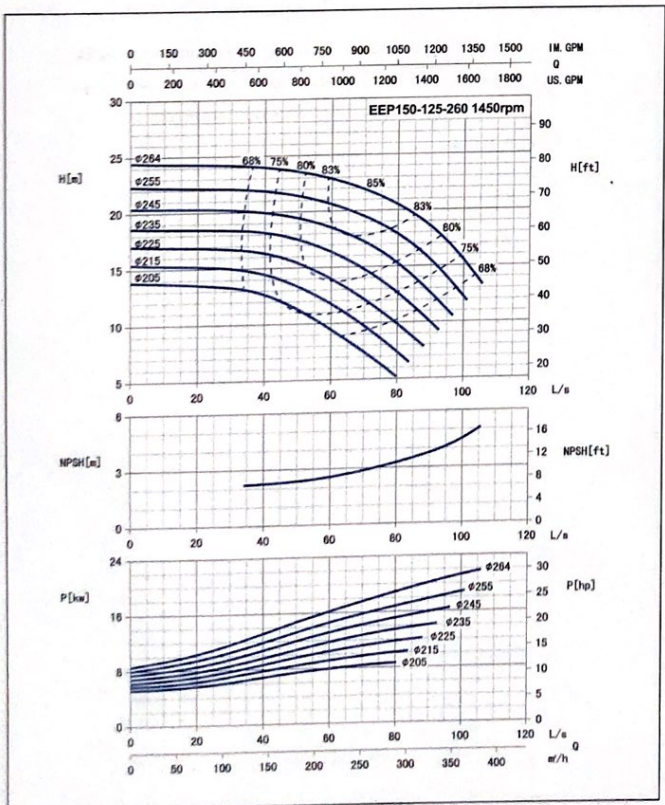
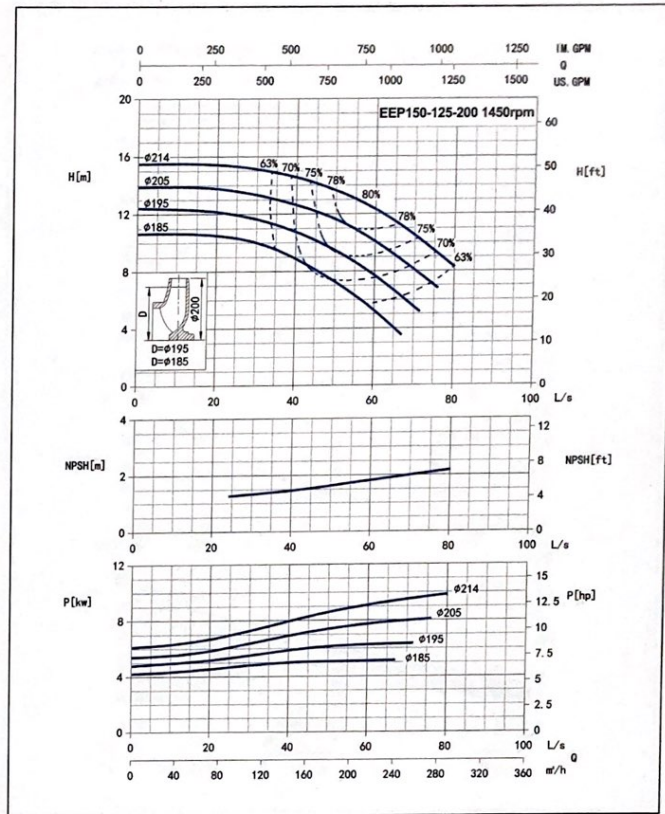
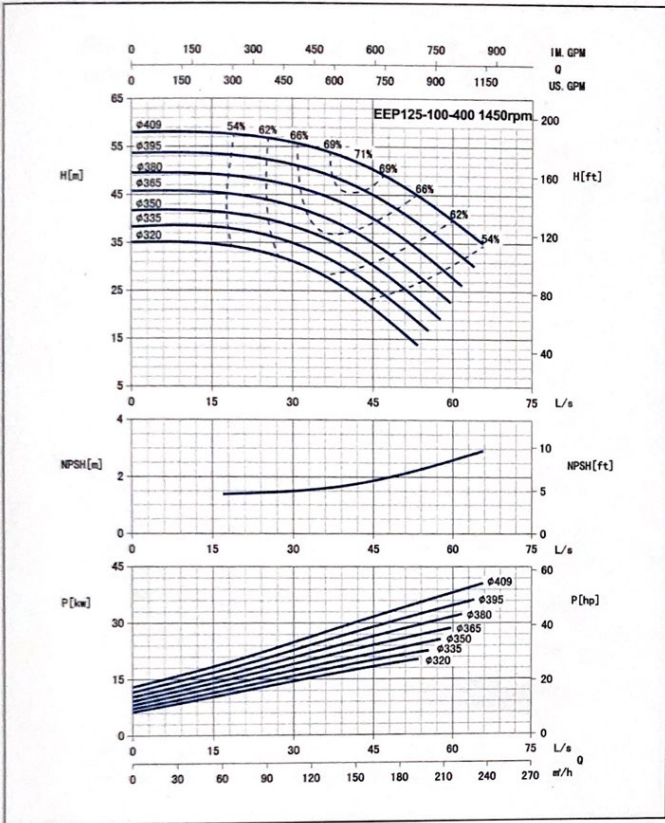

End Suction Centrifugal Pump

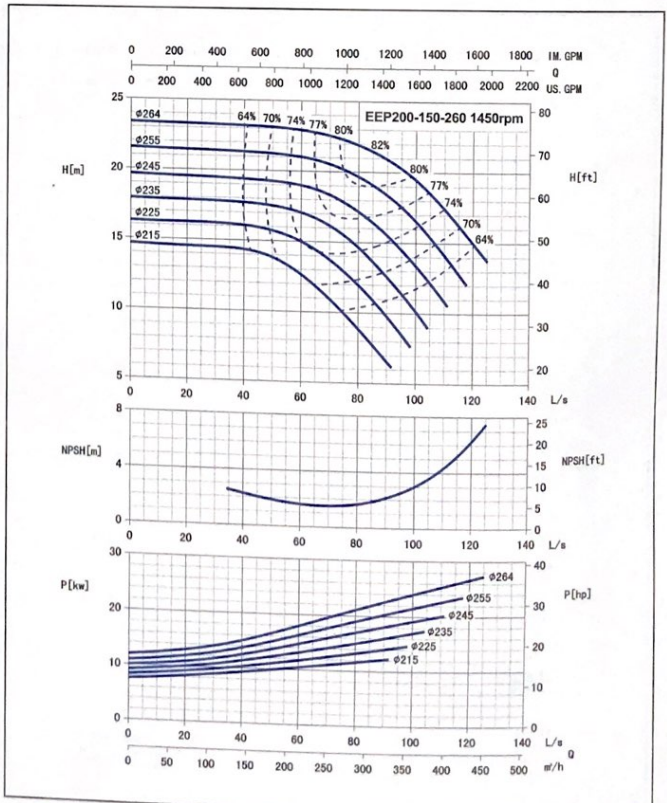
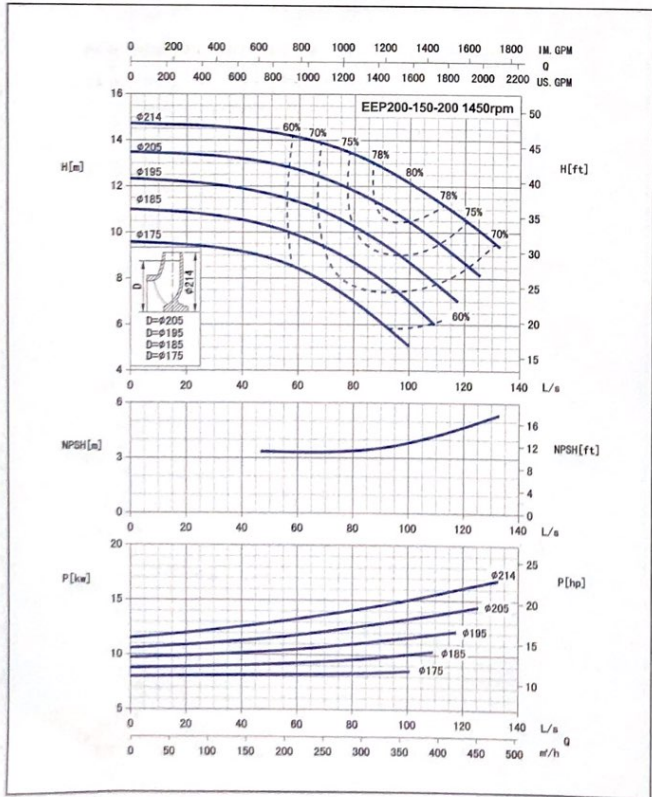
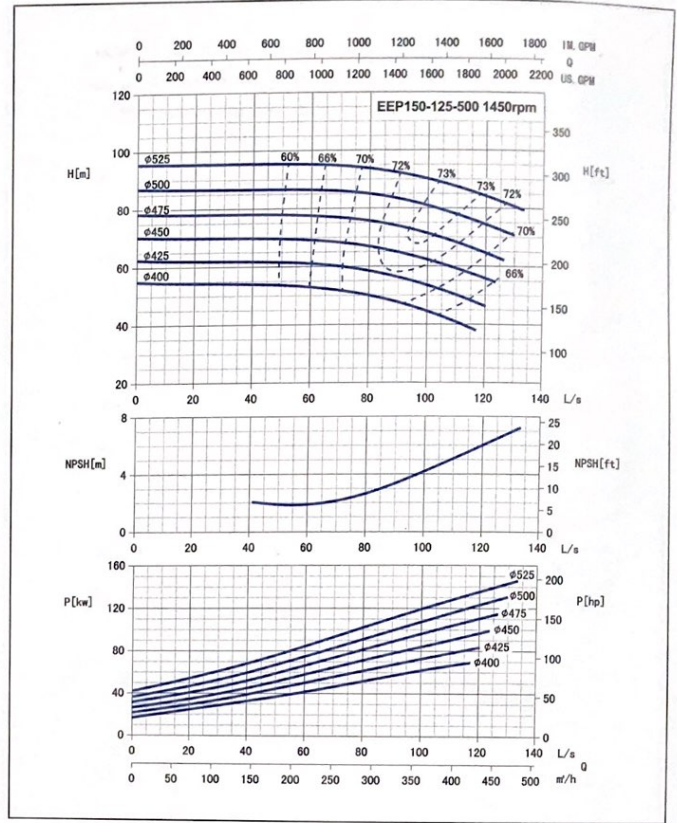
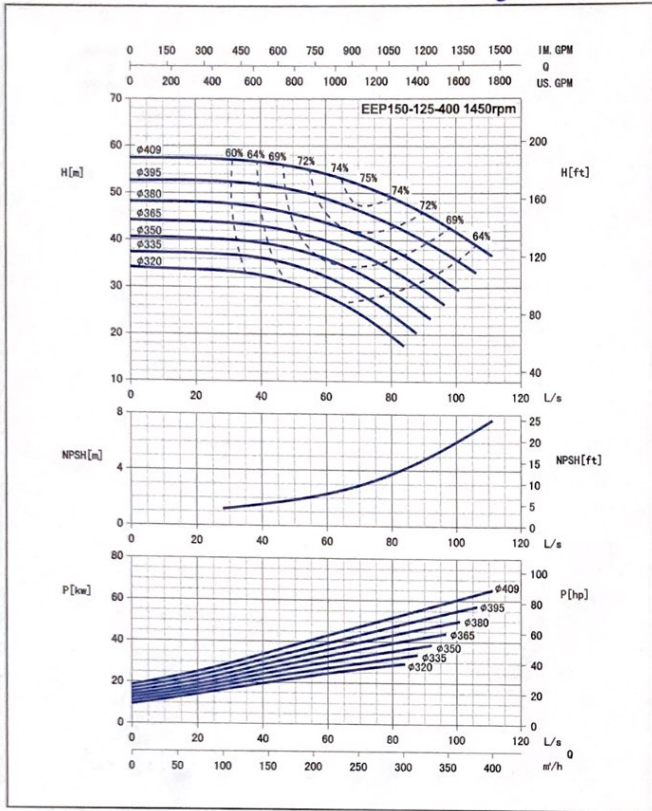

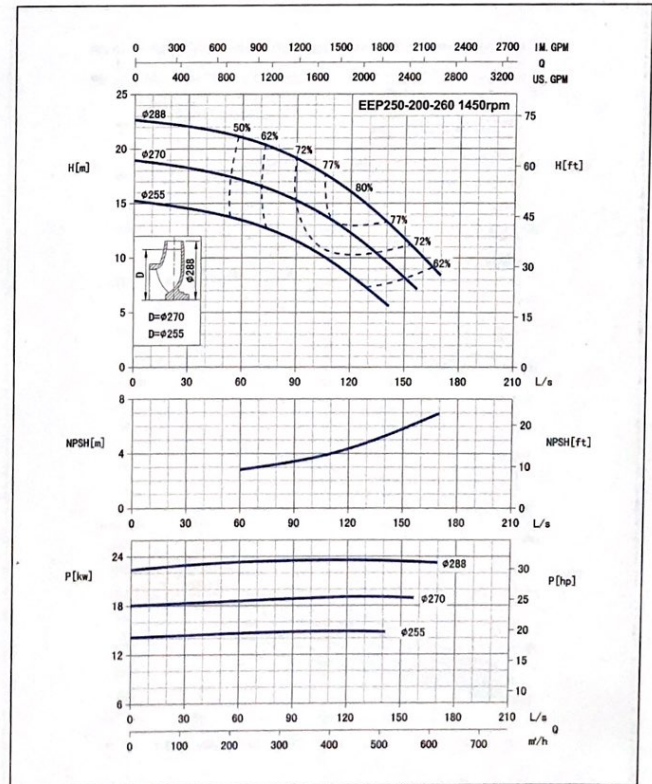
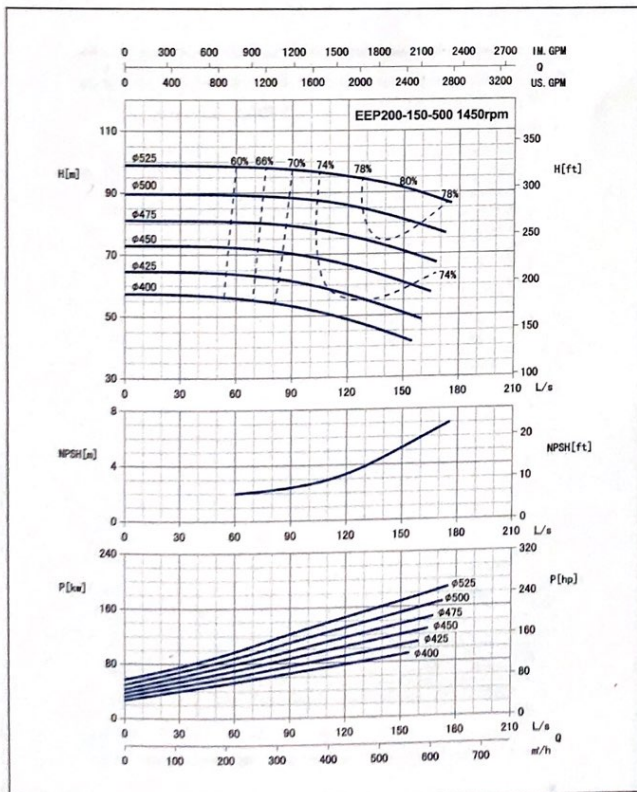
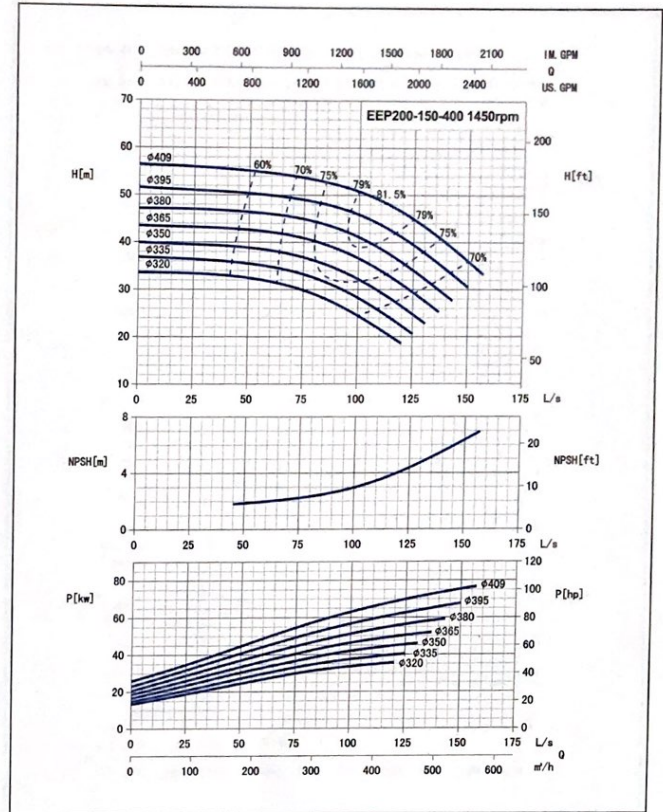
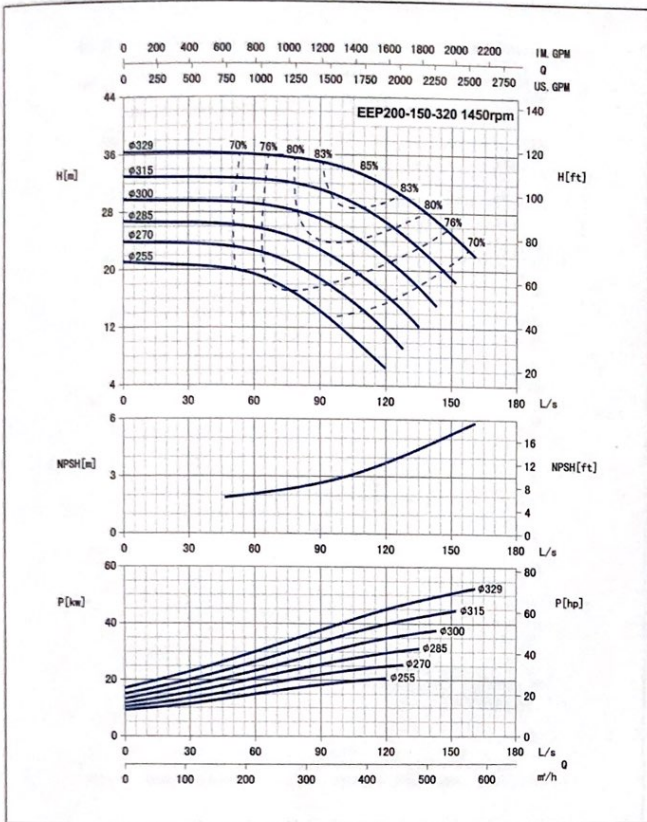

End Suction Centrifugal Pump

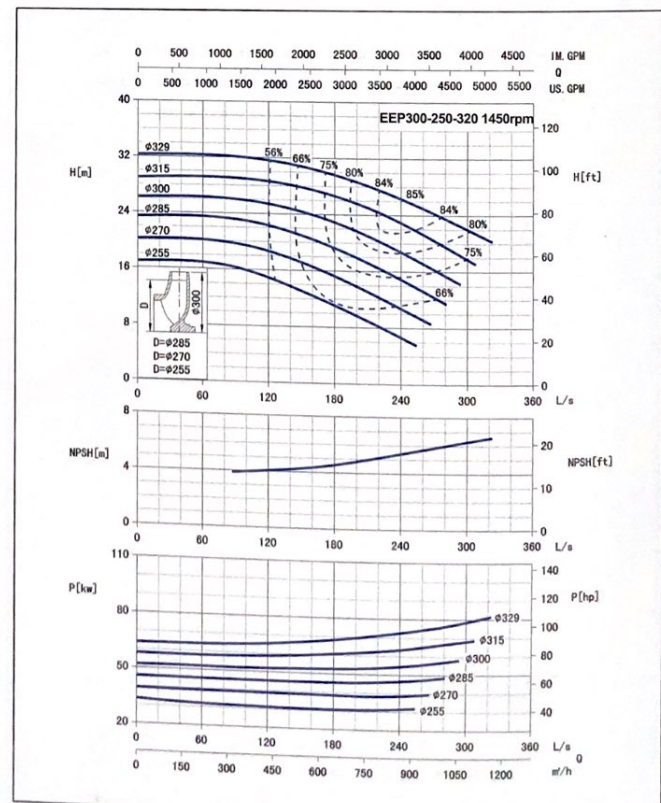
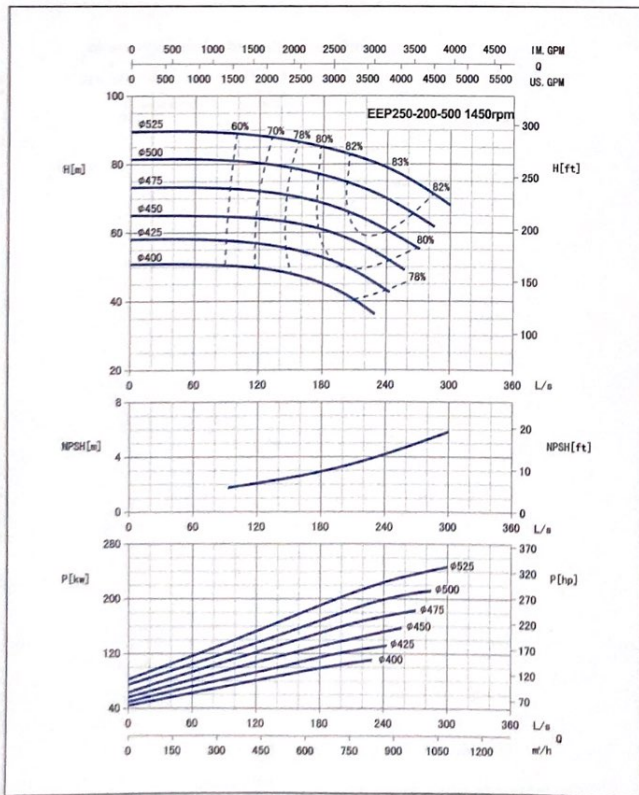
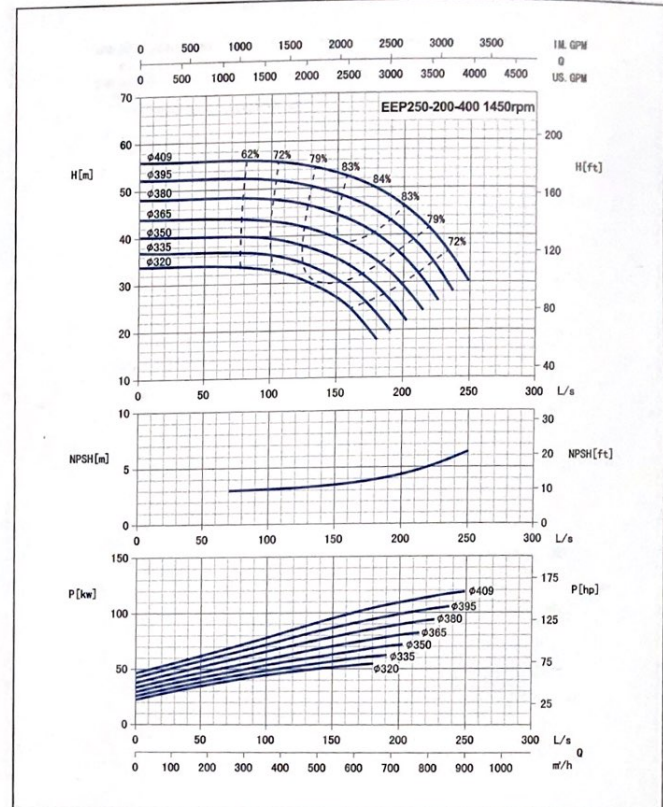
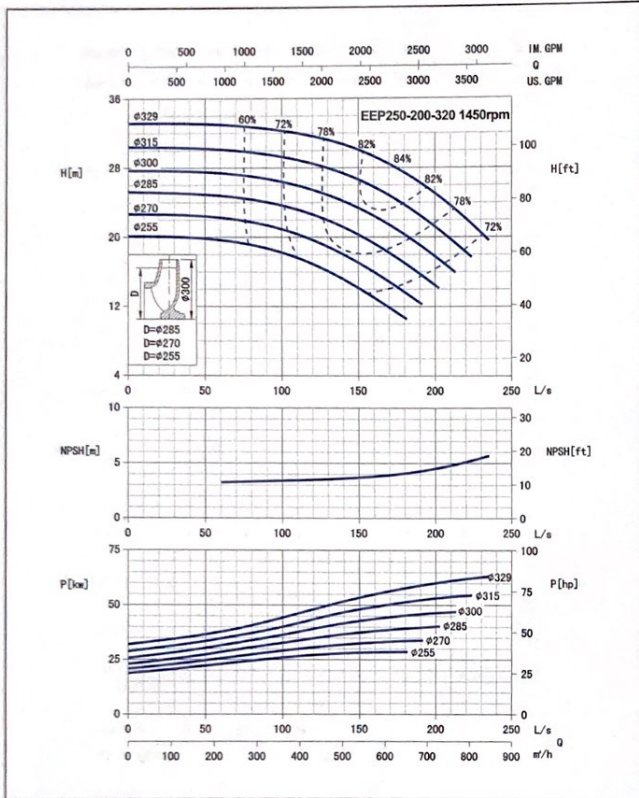

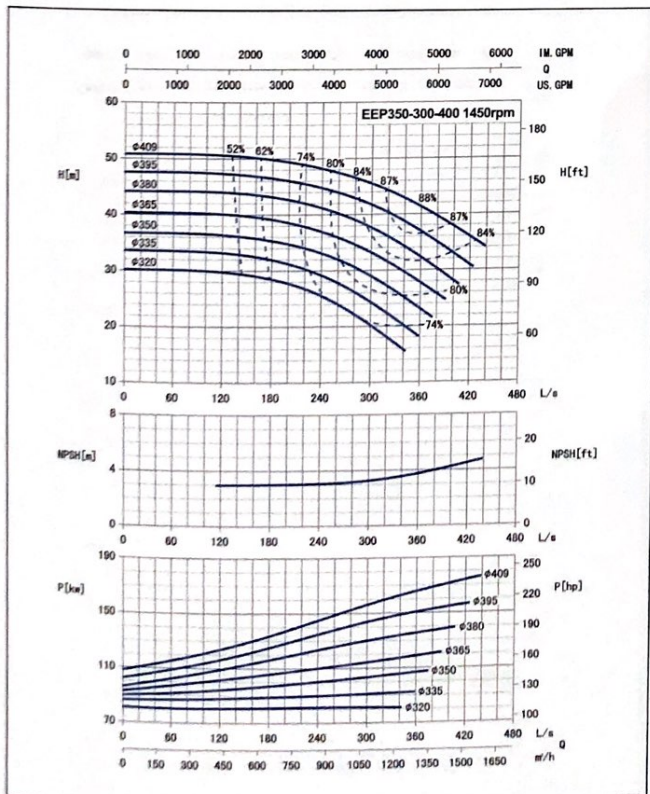
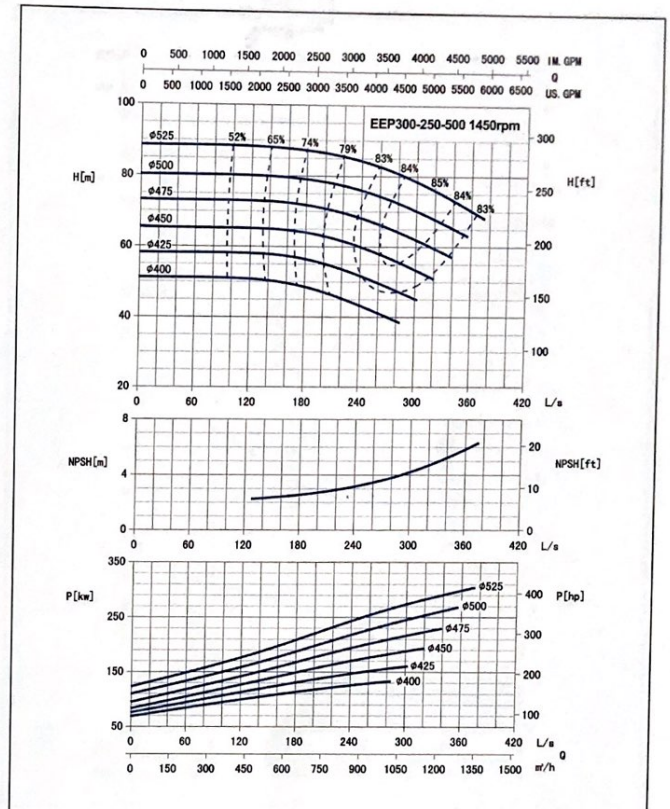
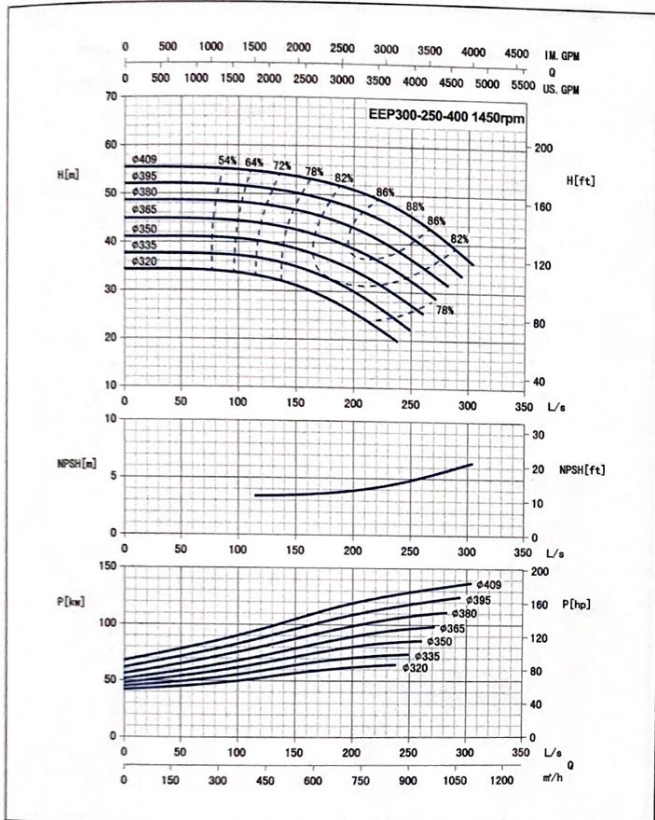

End Suction Centrifugal Pump

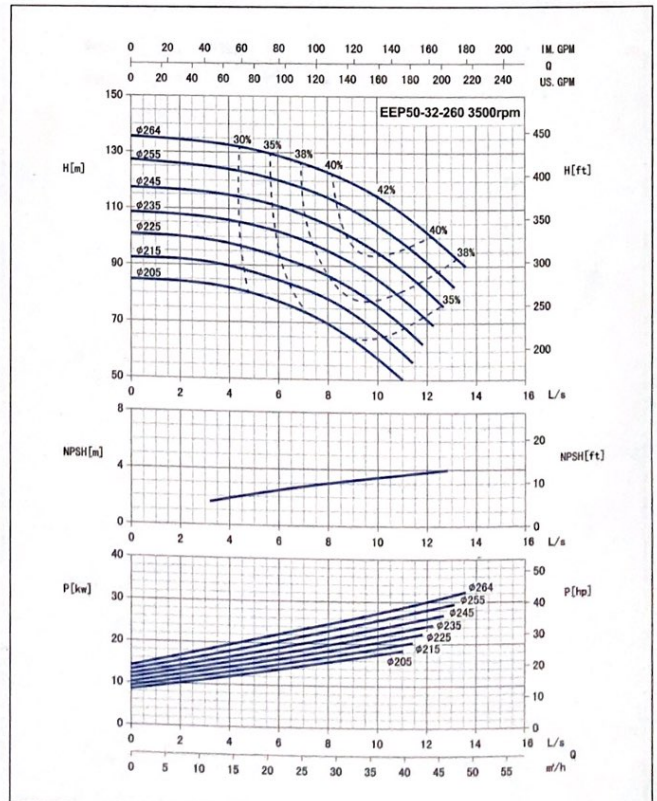
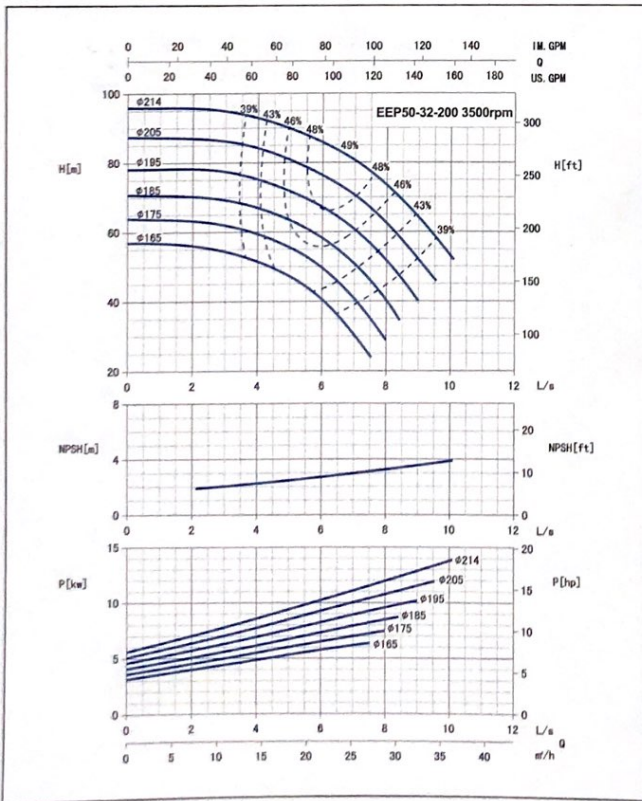
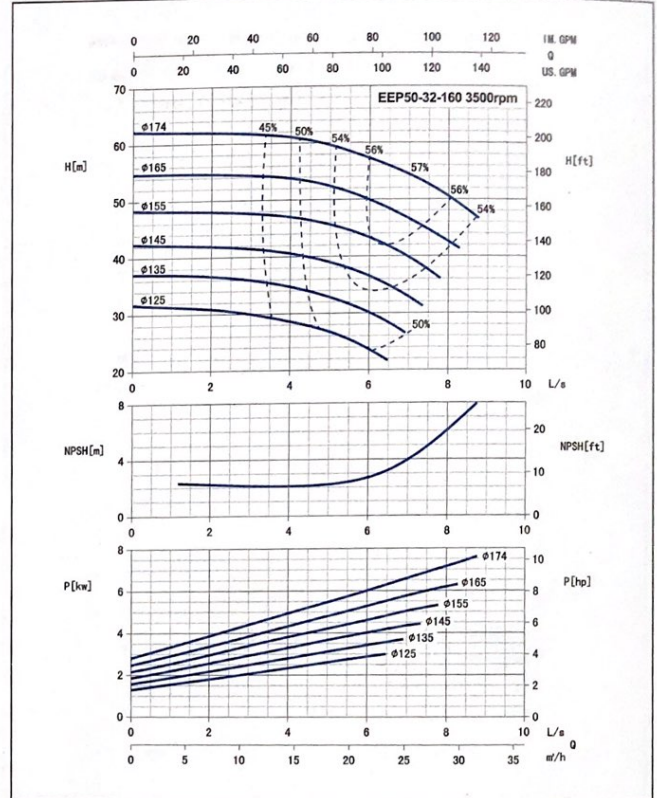
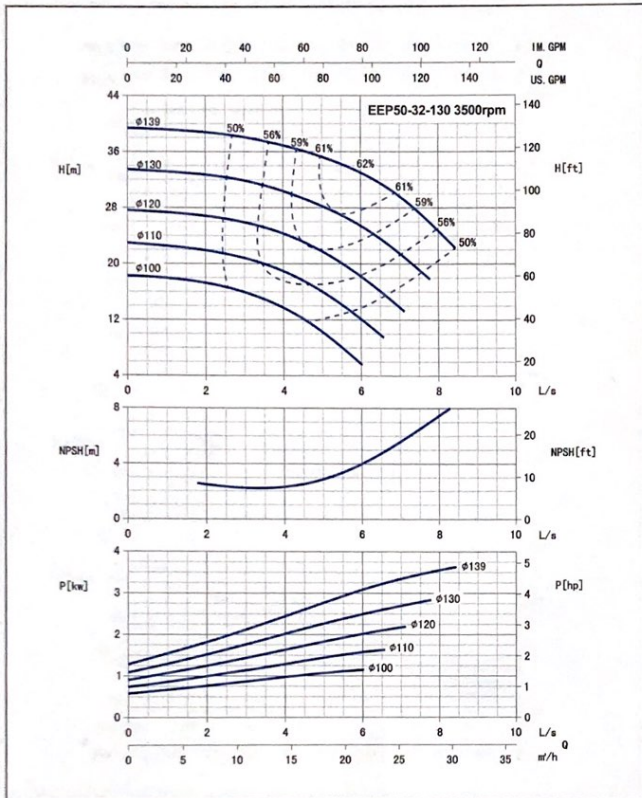

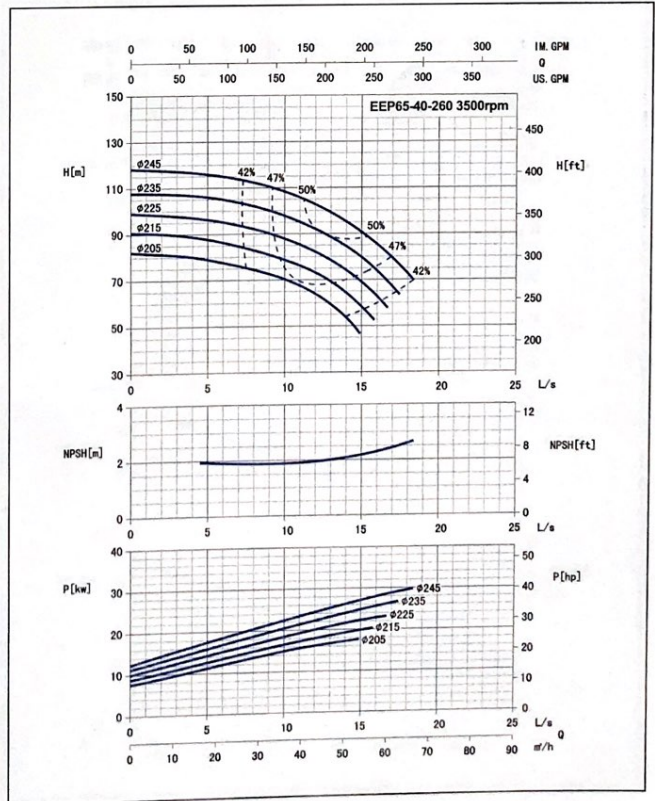
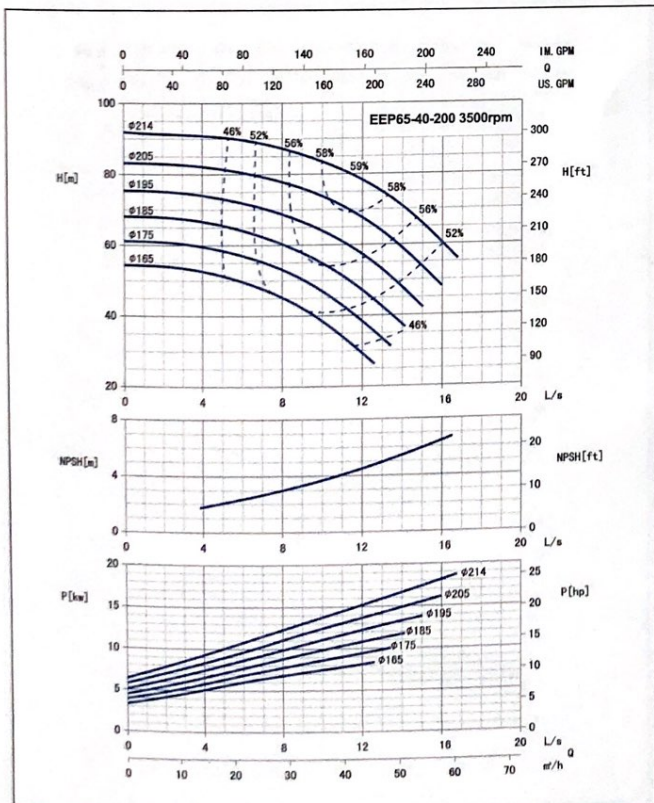
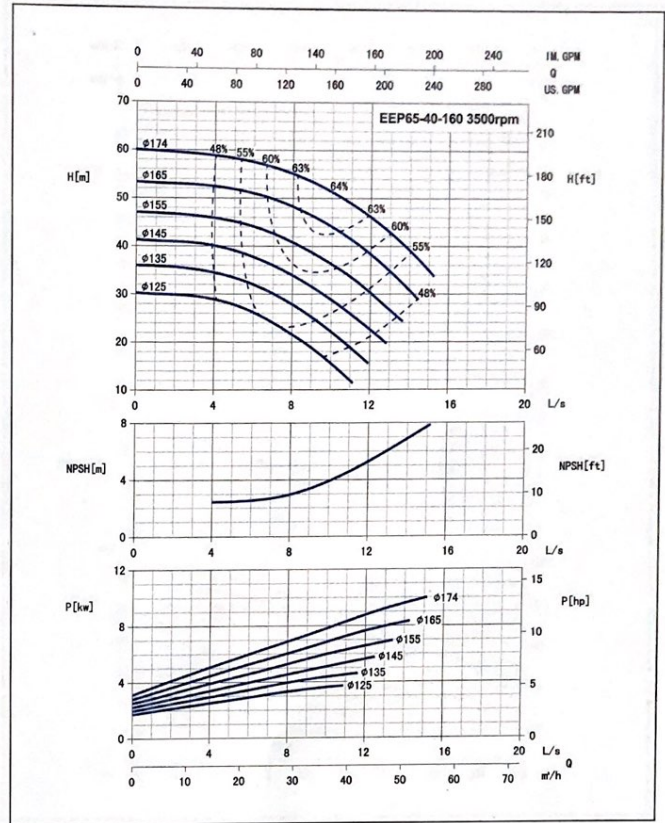
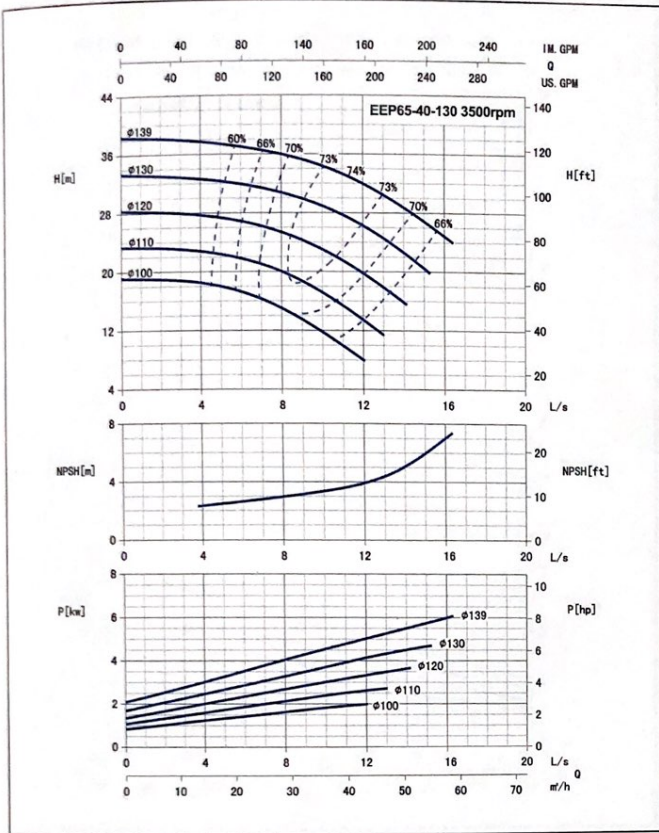

End Suction Centrifugal Pump

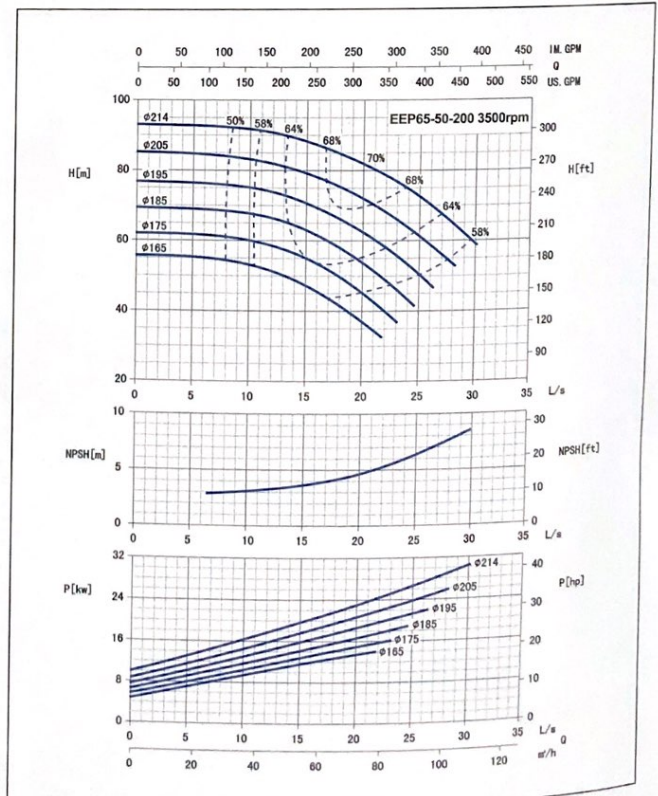
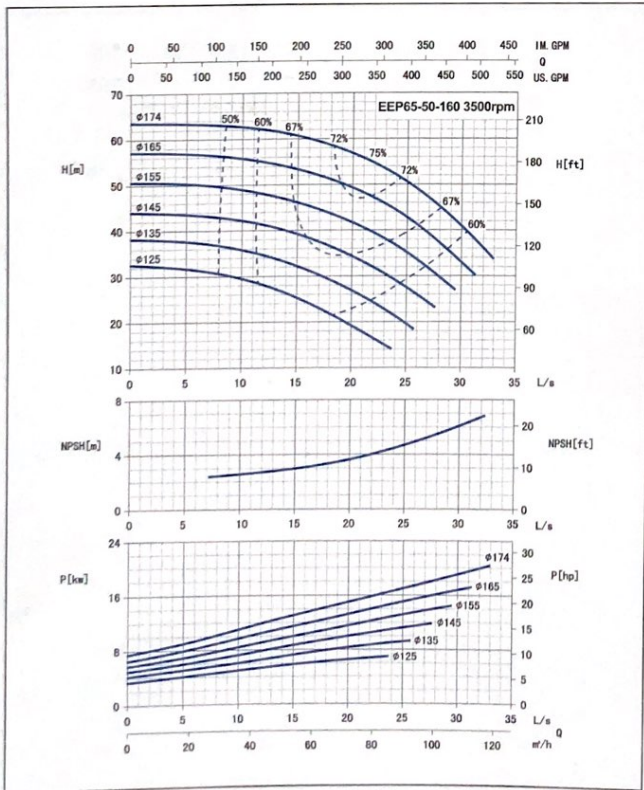
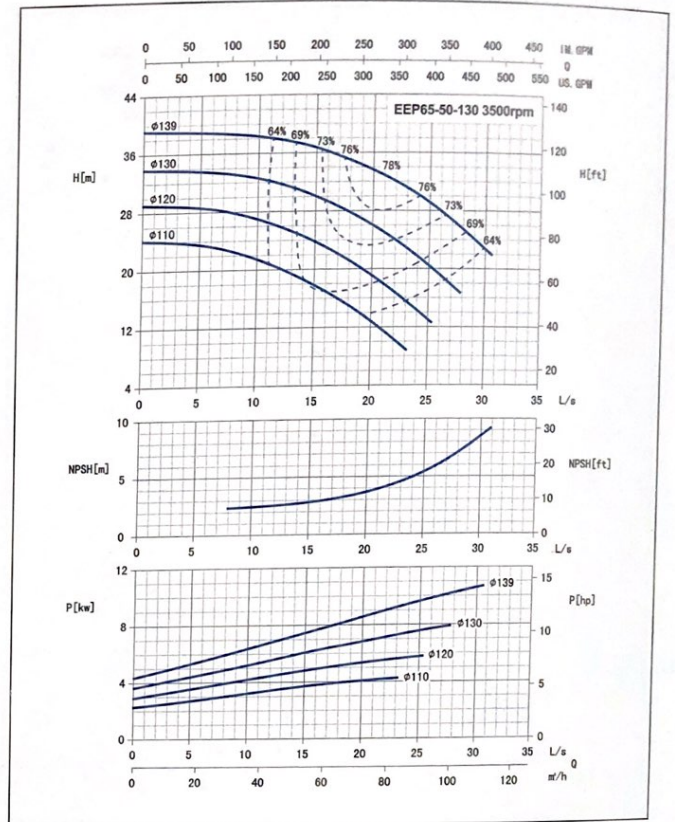
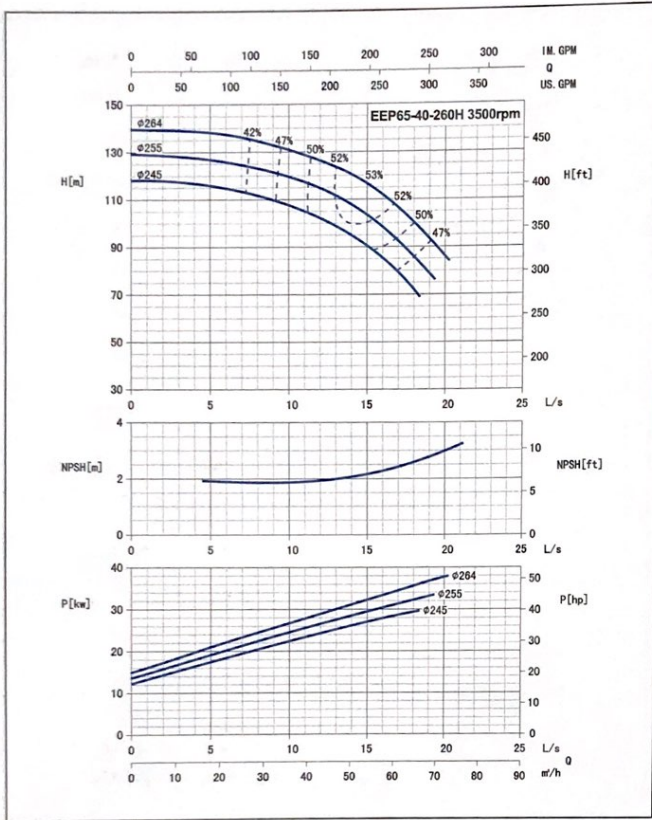

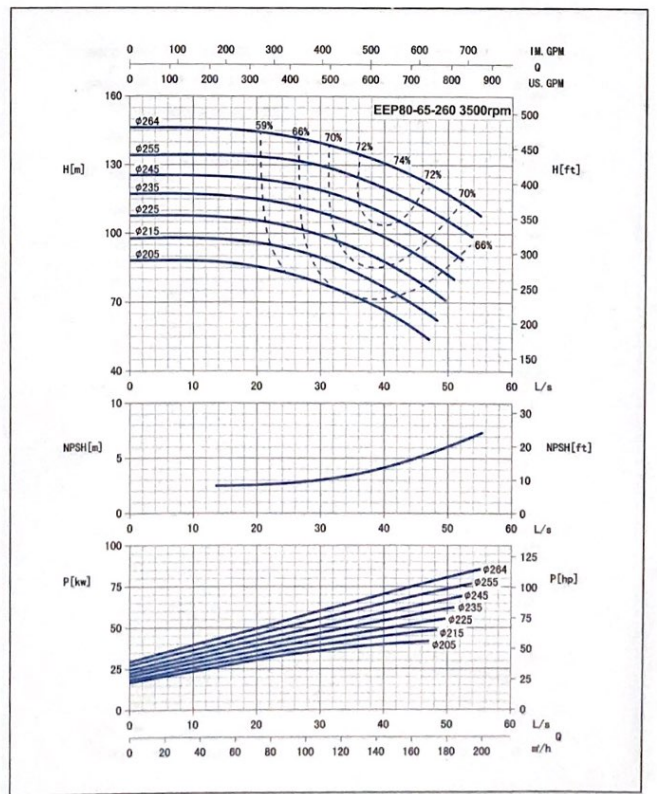
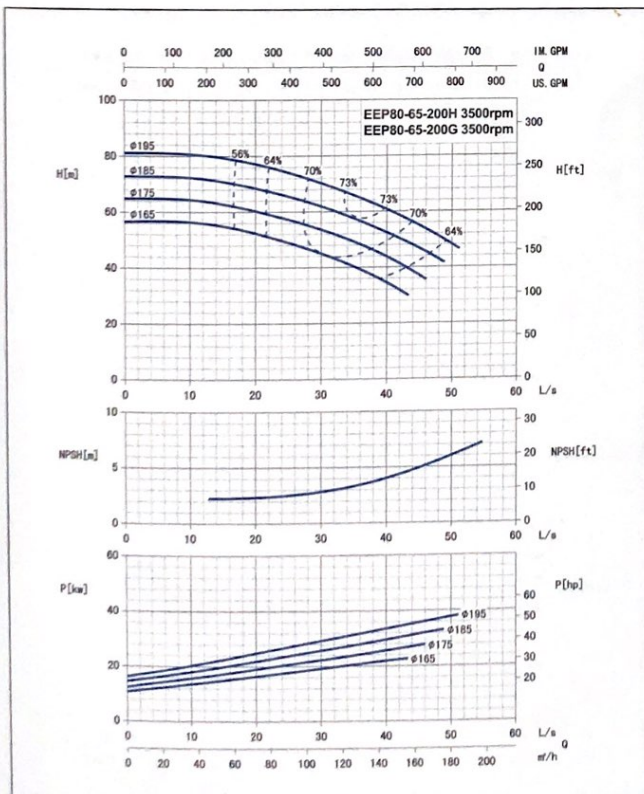
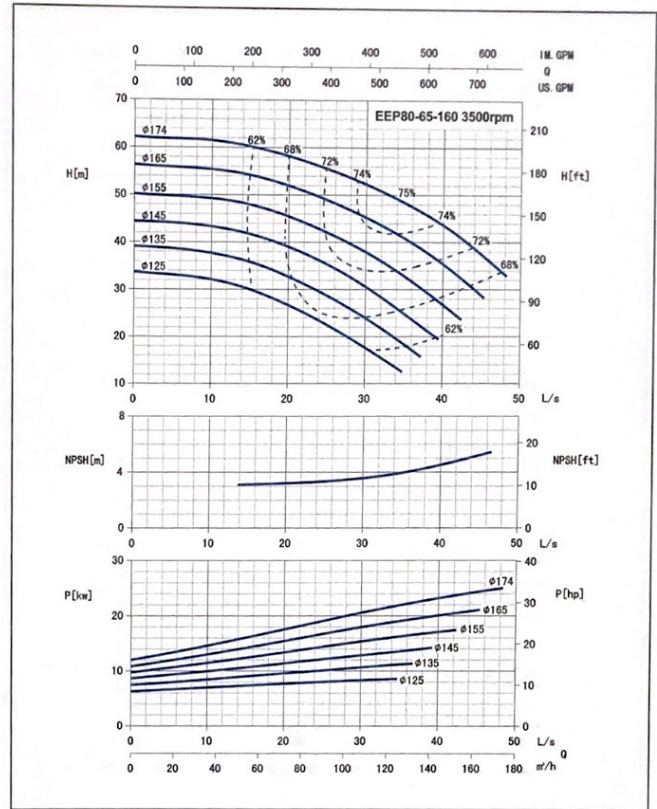
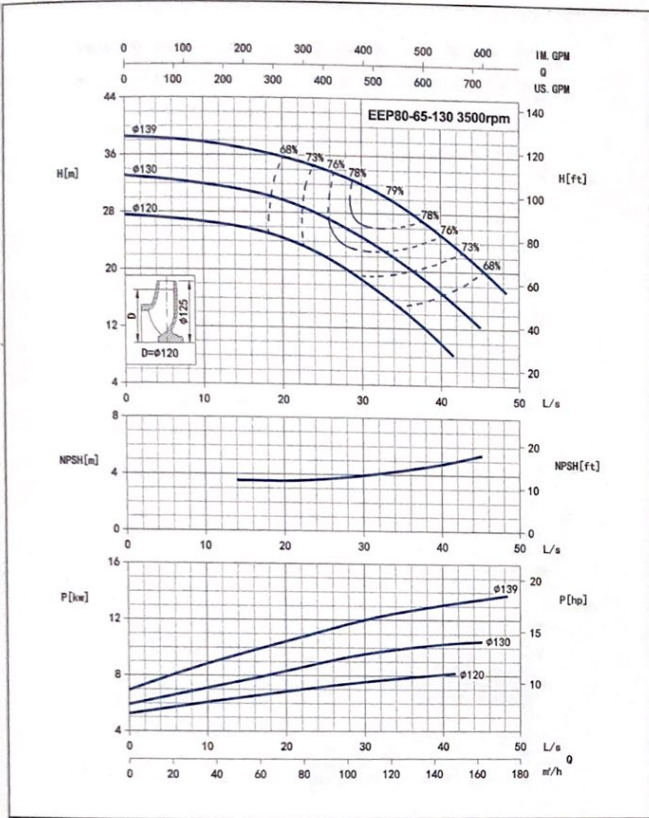

End Suction Centrifugal Pump

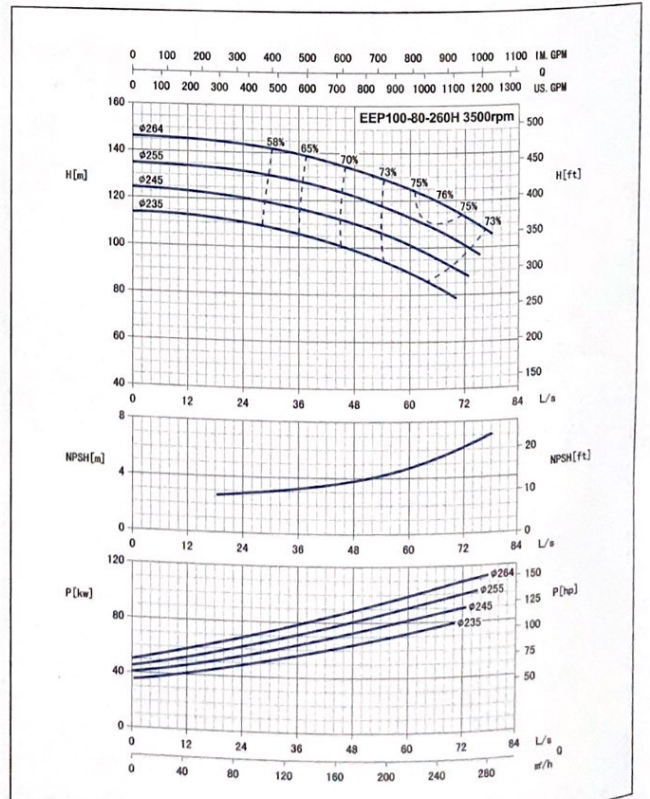
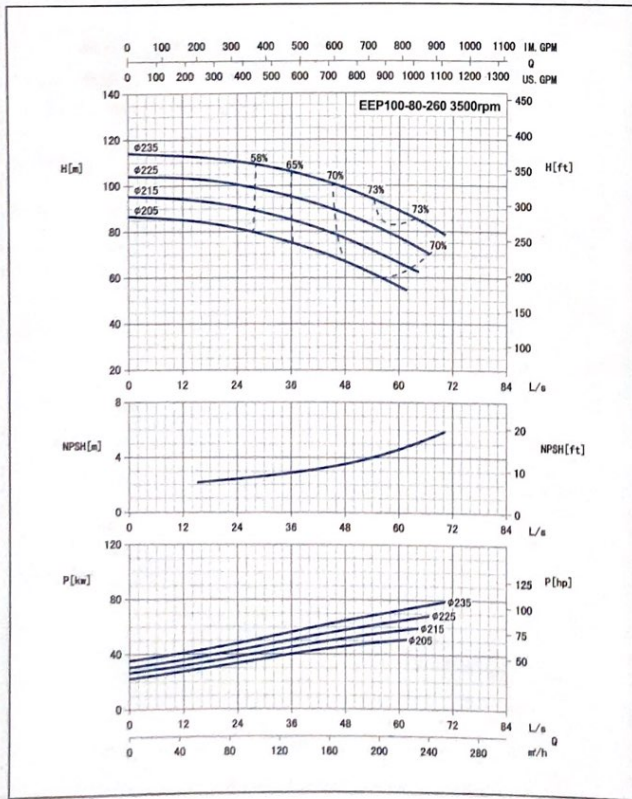
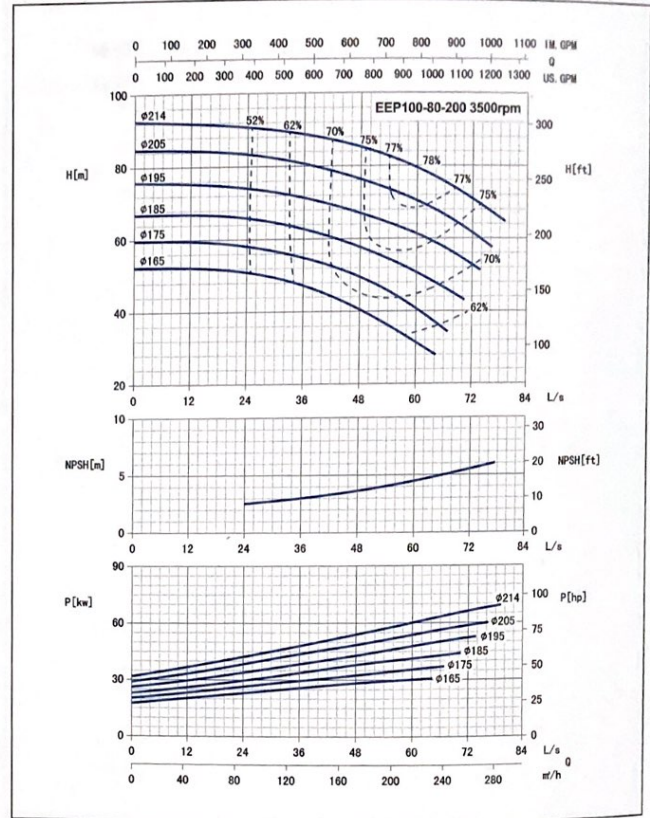
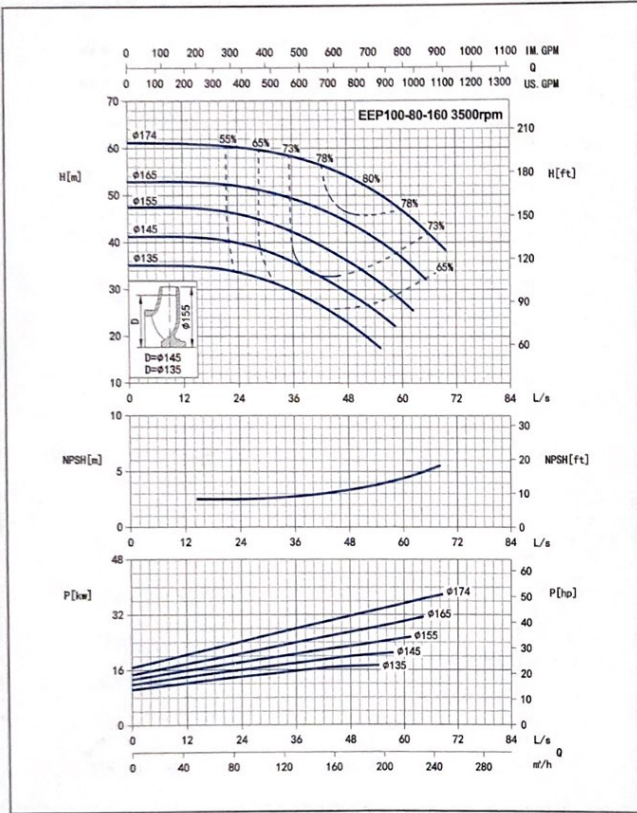

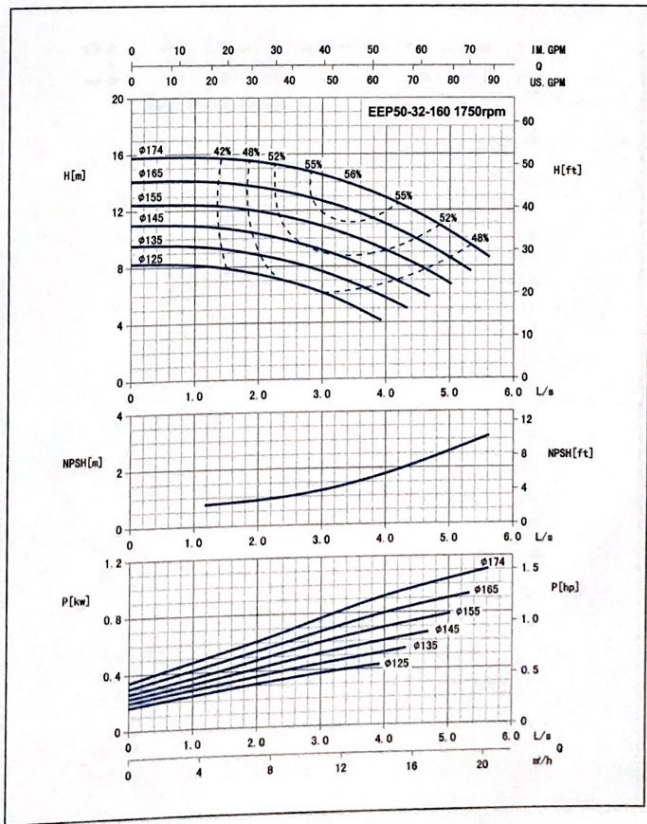
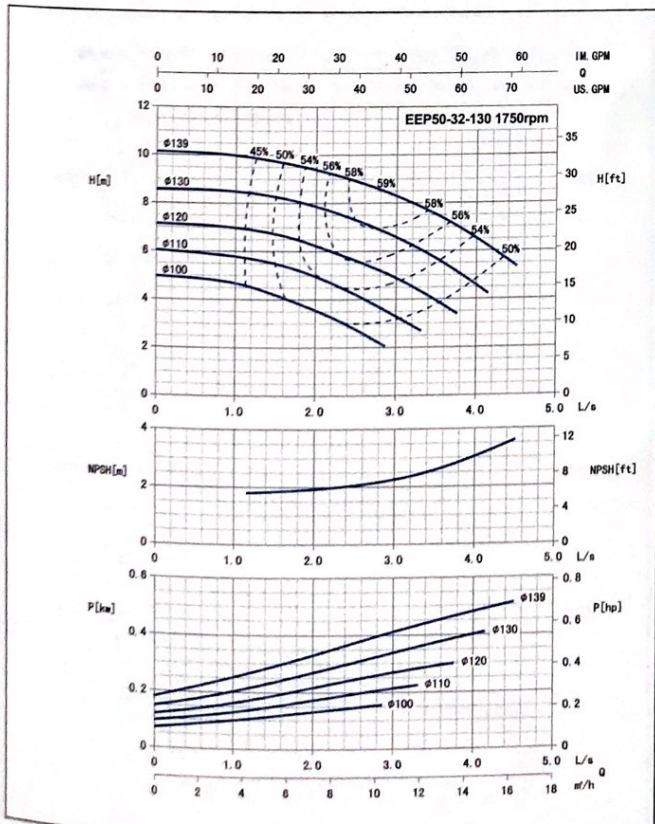
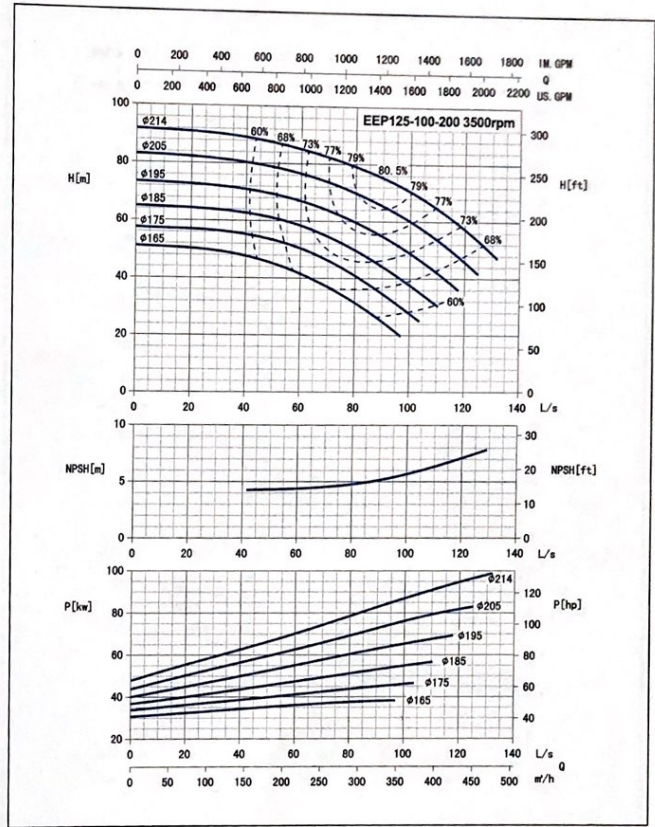
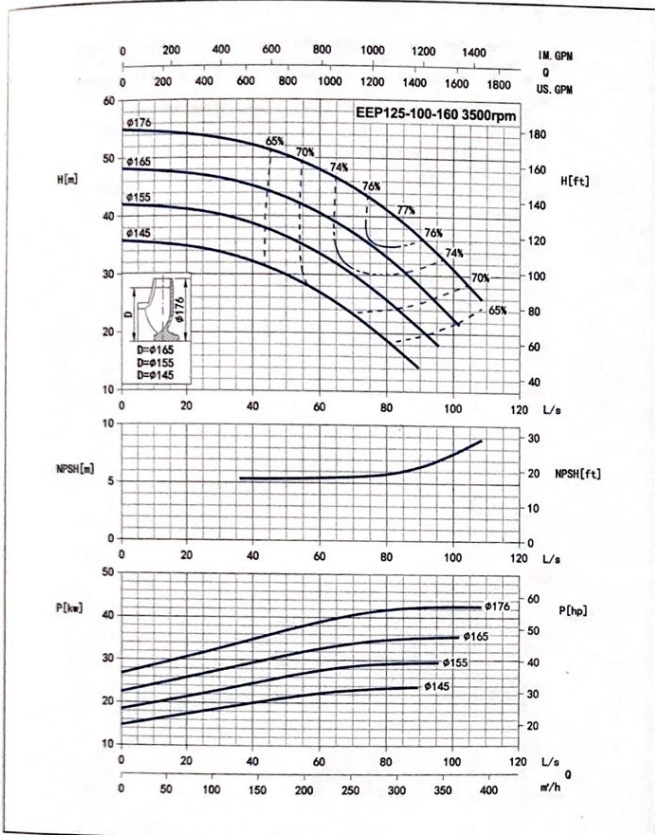

End Suction Centrifugal Pump

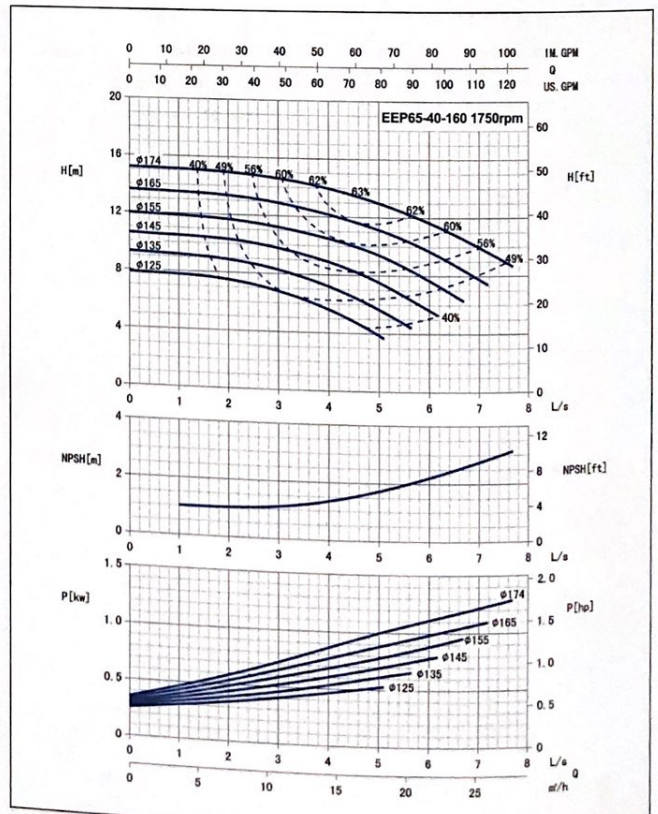
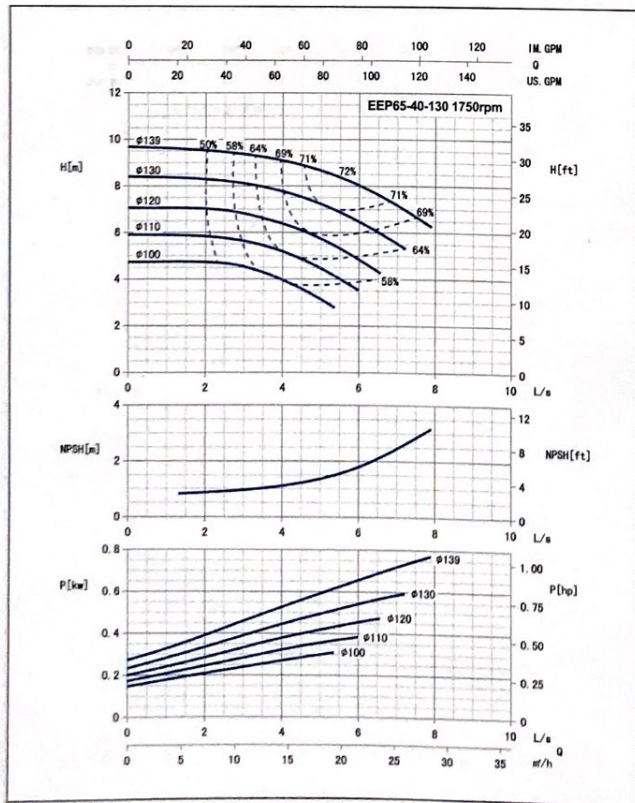
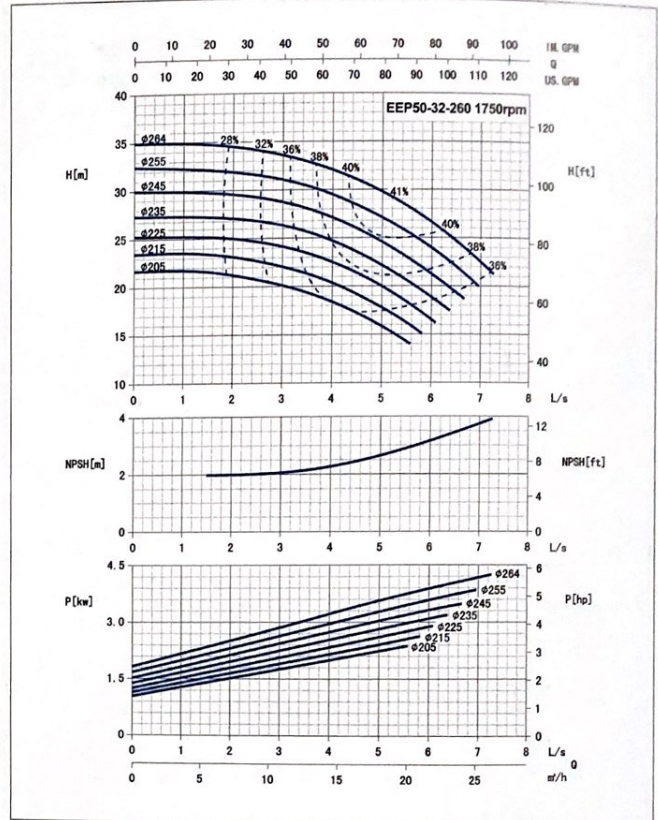
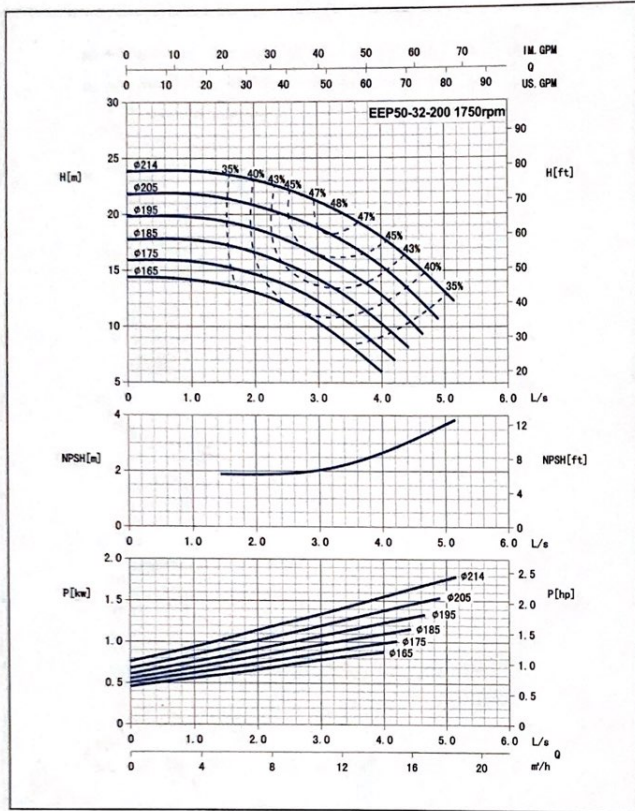

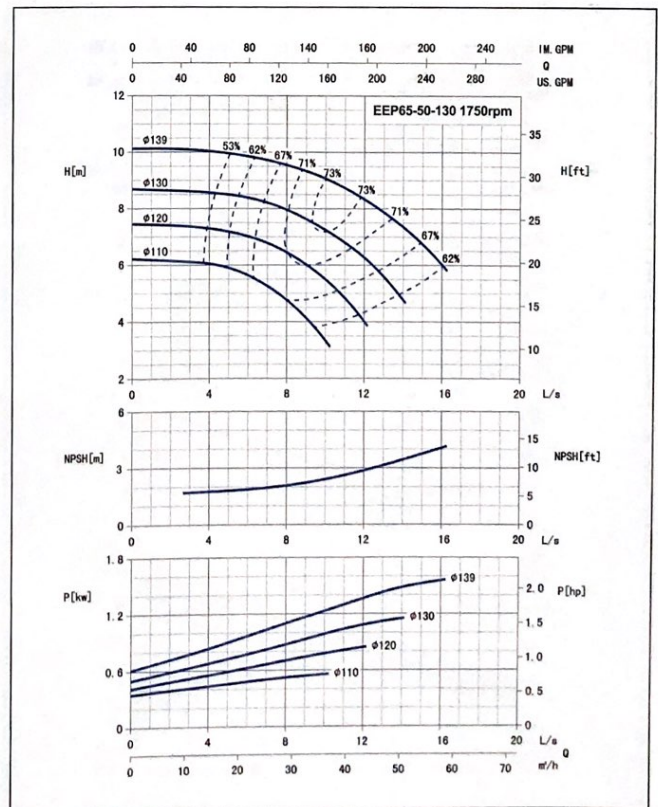
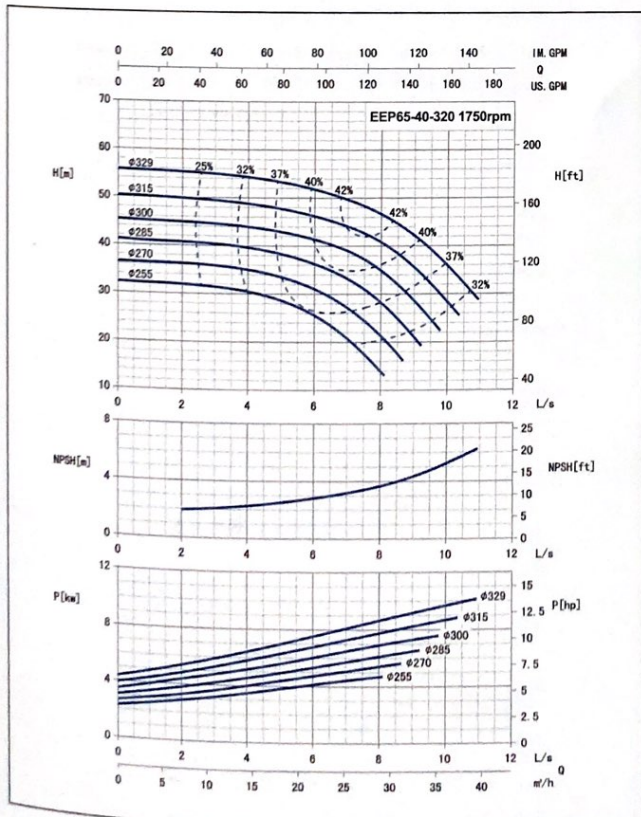
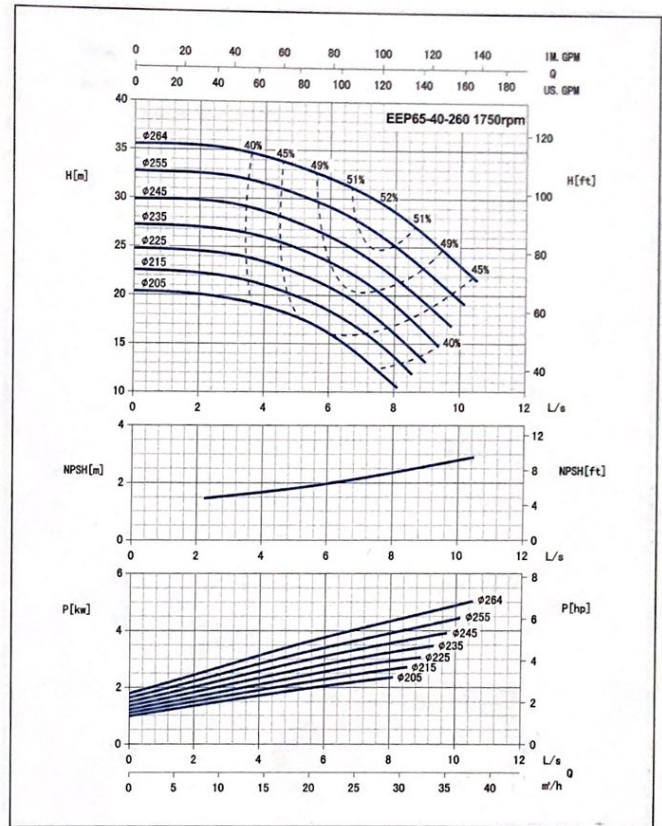
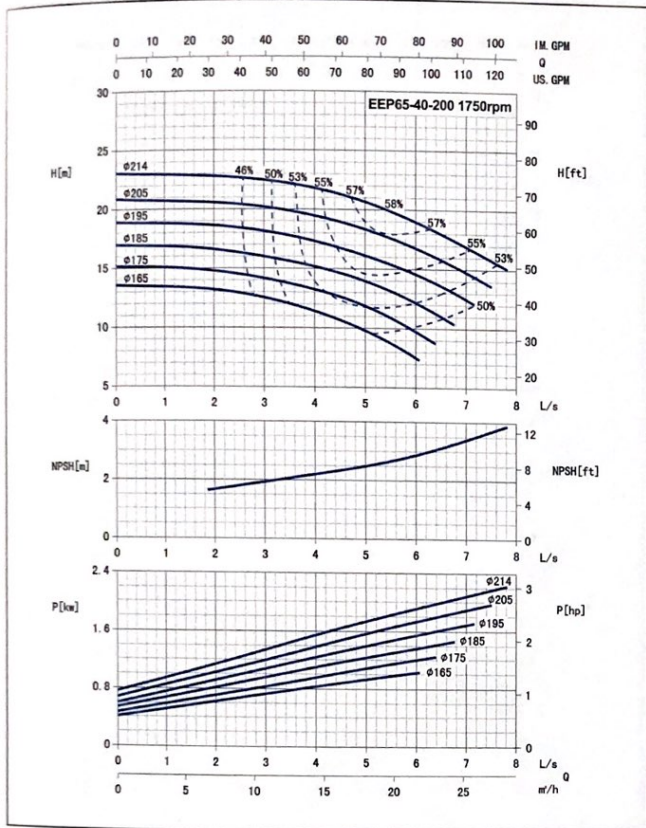

End Suction Centrifugal Pump

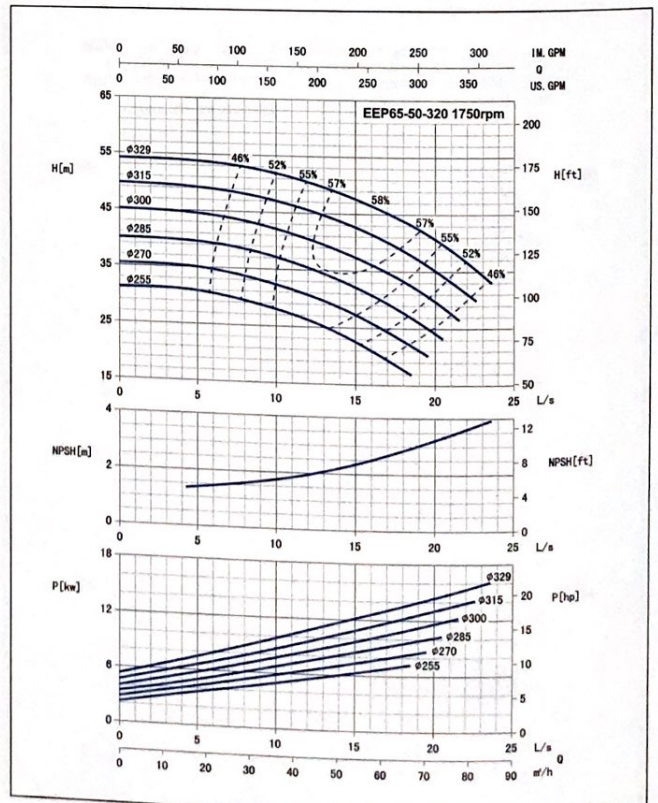
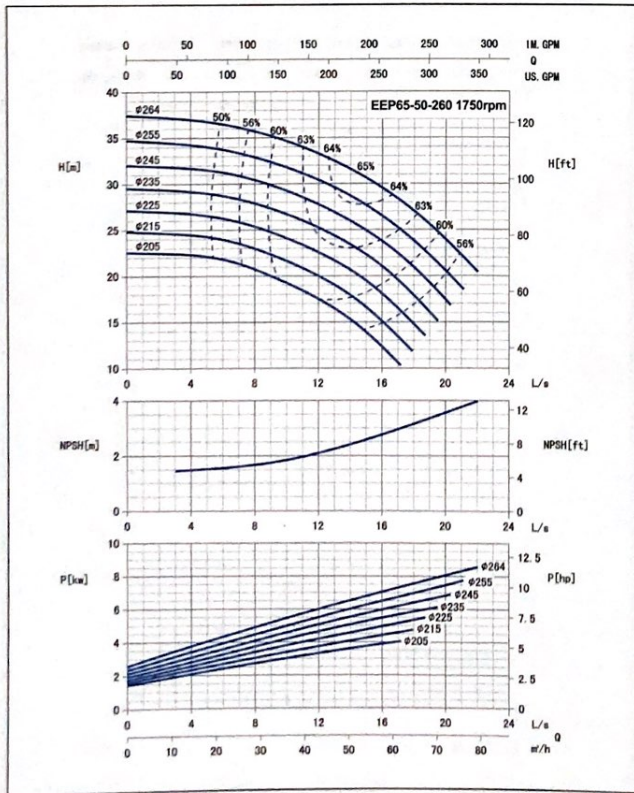
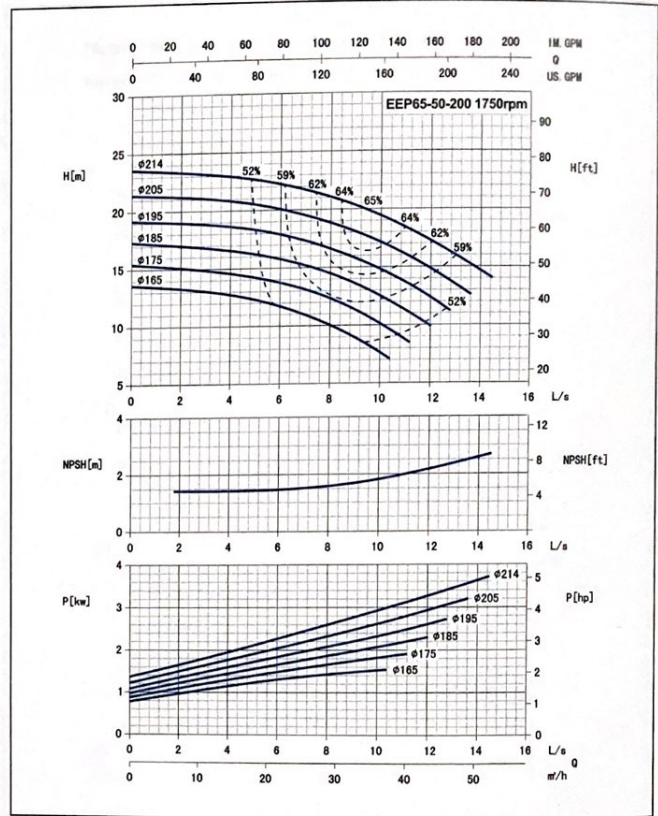
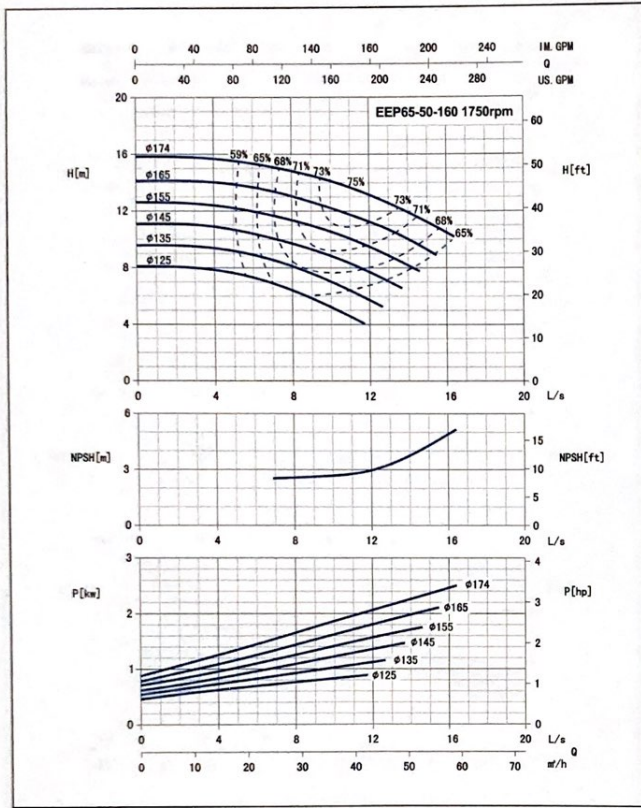

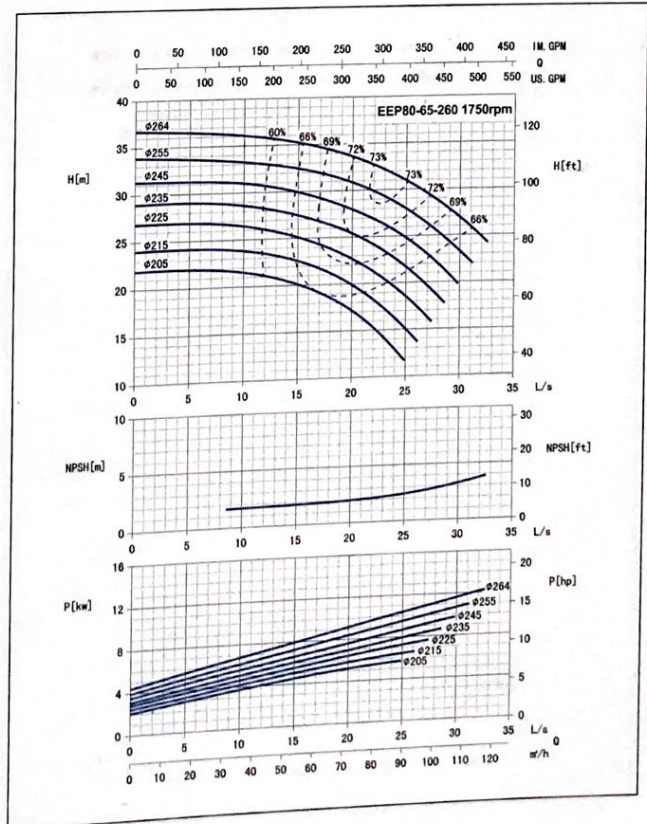
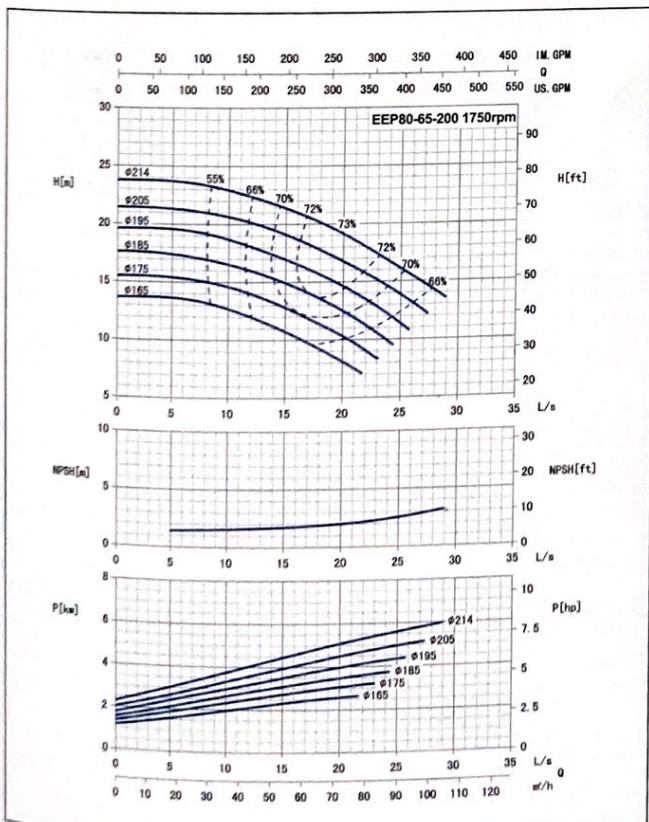
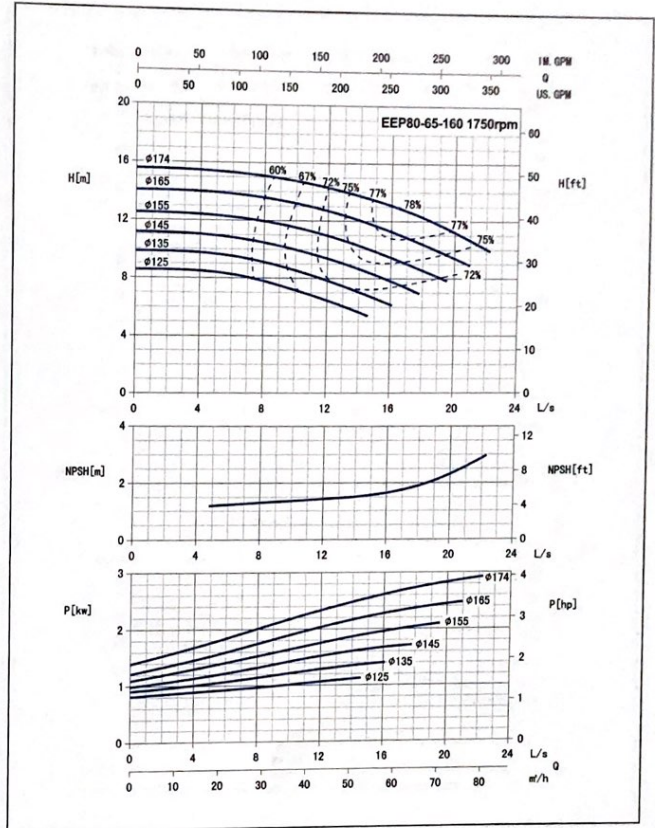
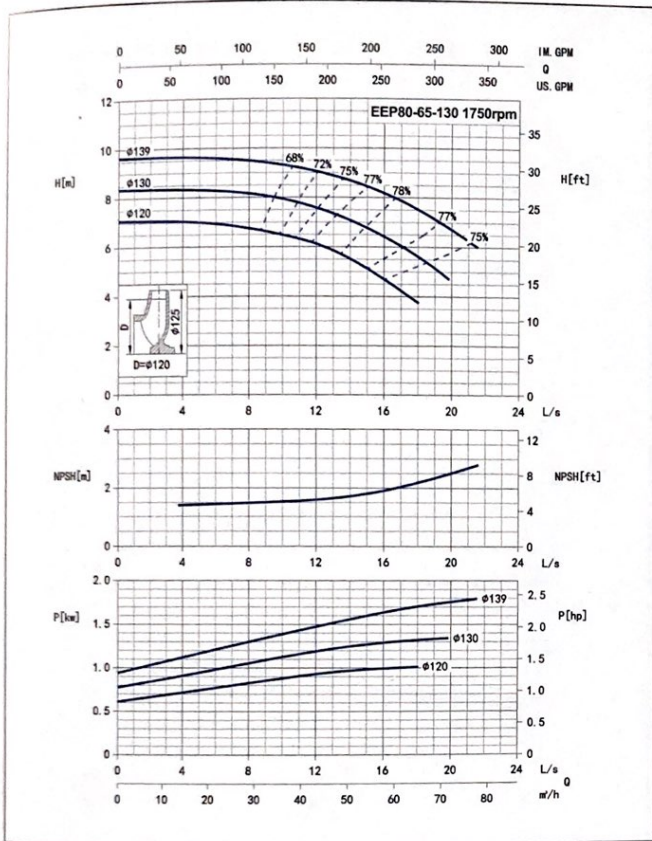

End Suction Centrifugal Pump

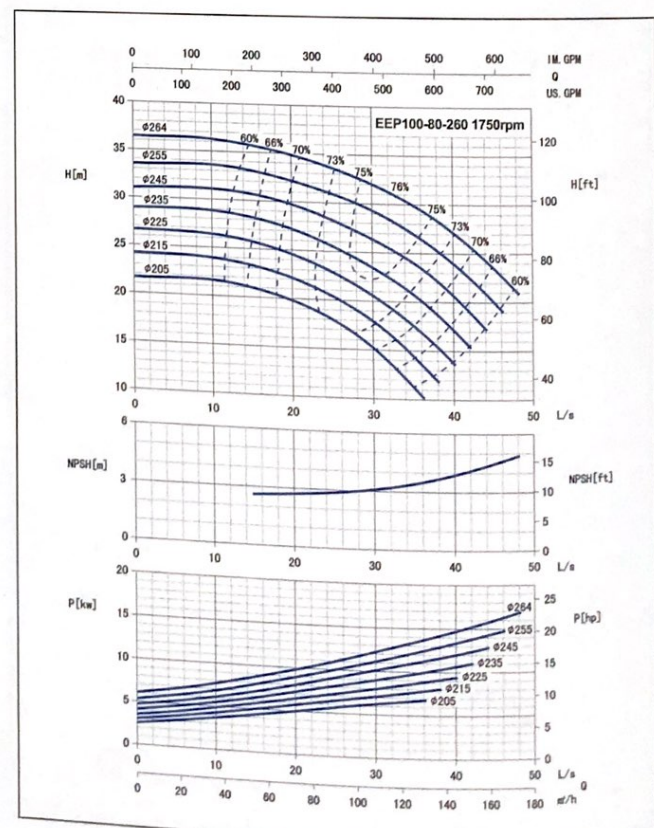
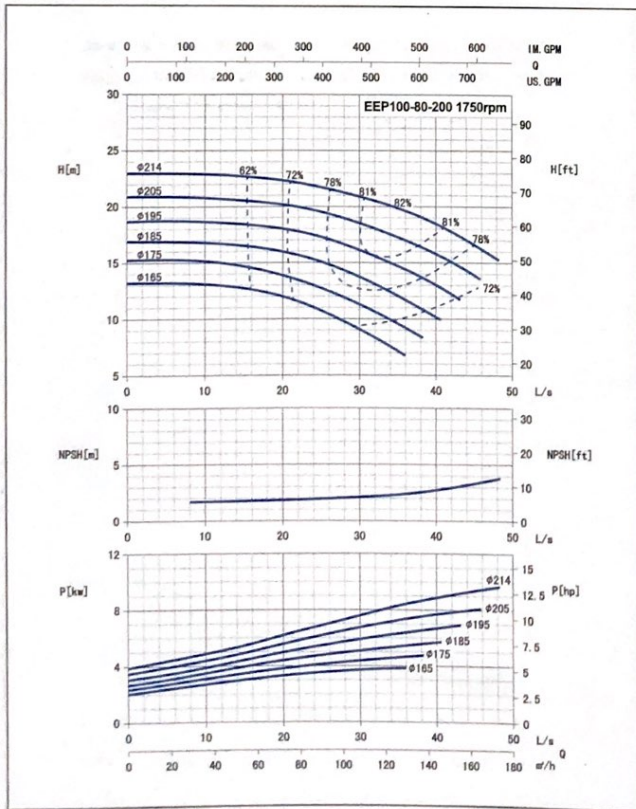
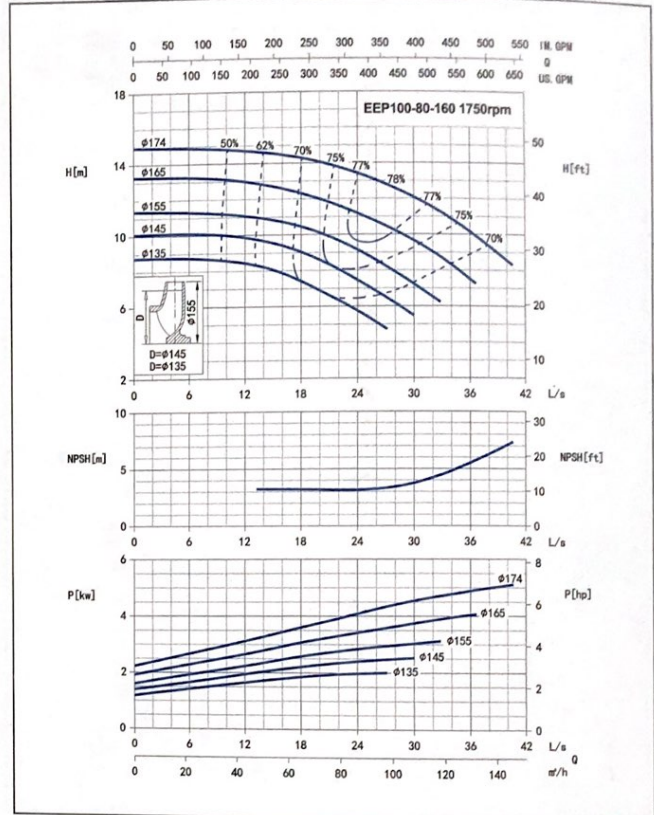
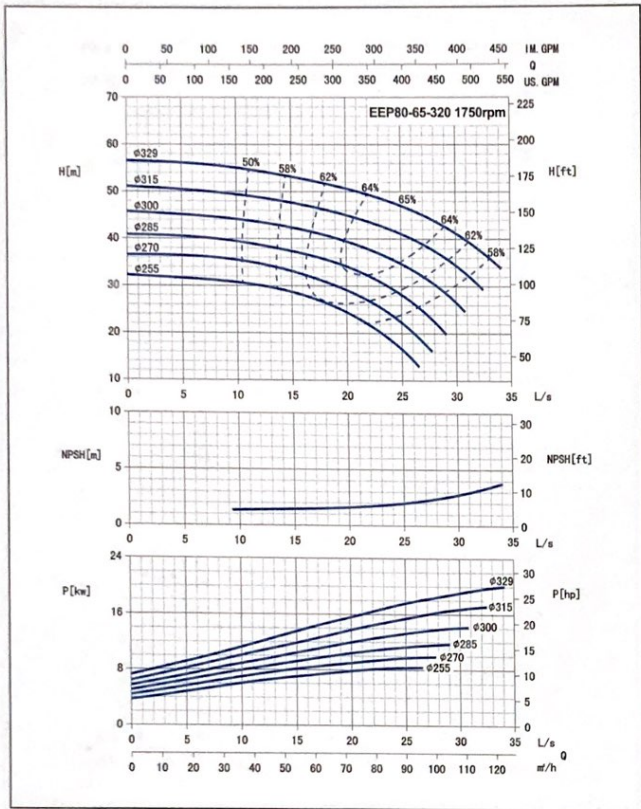

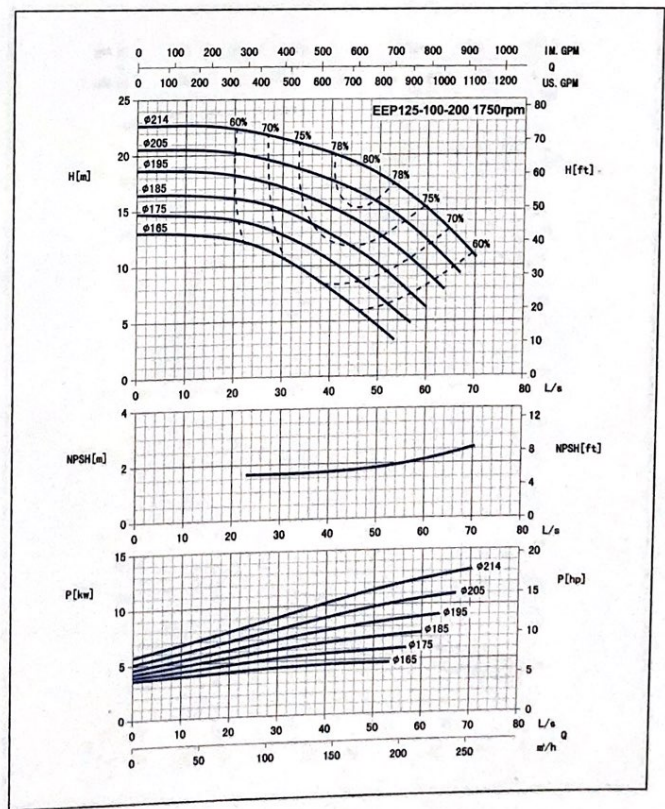
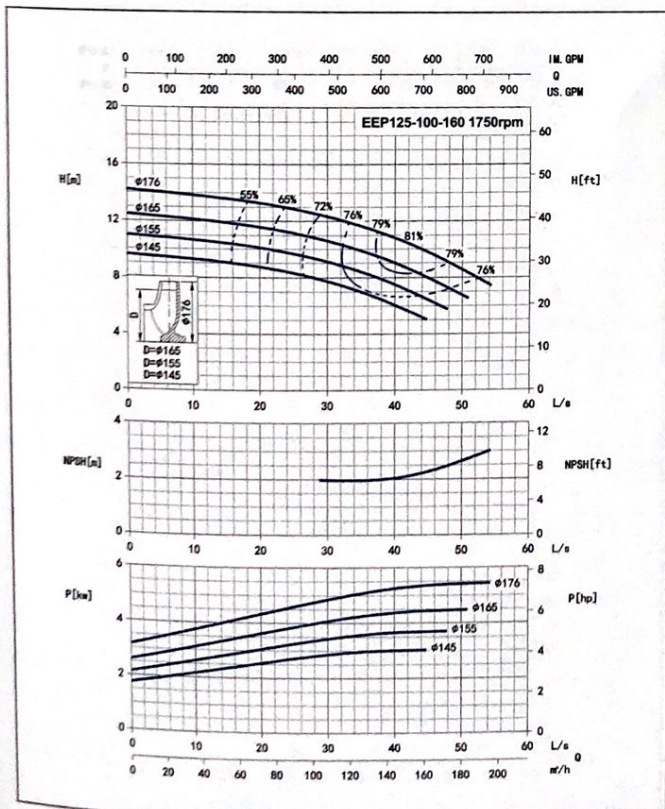
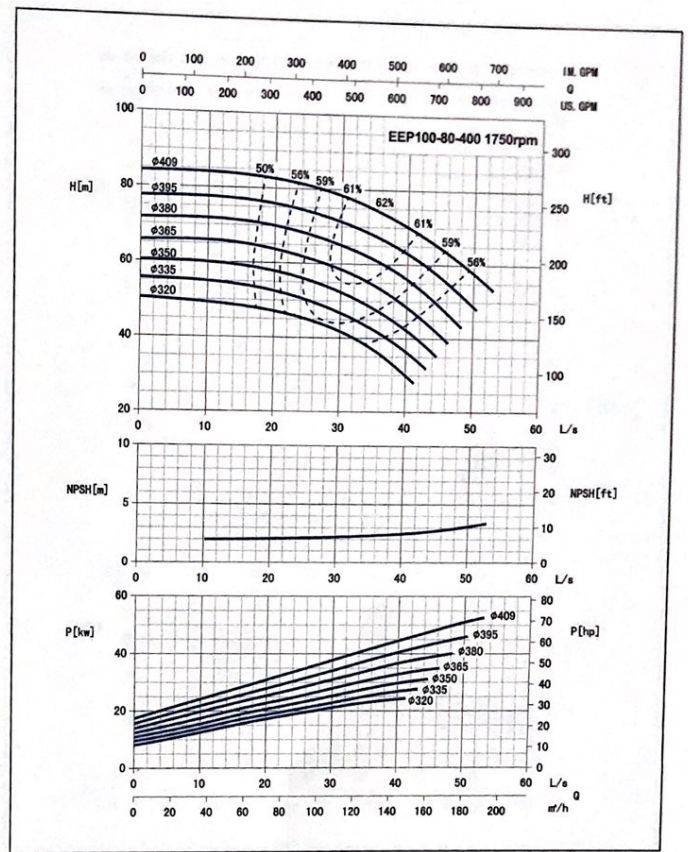
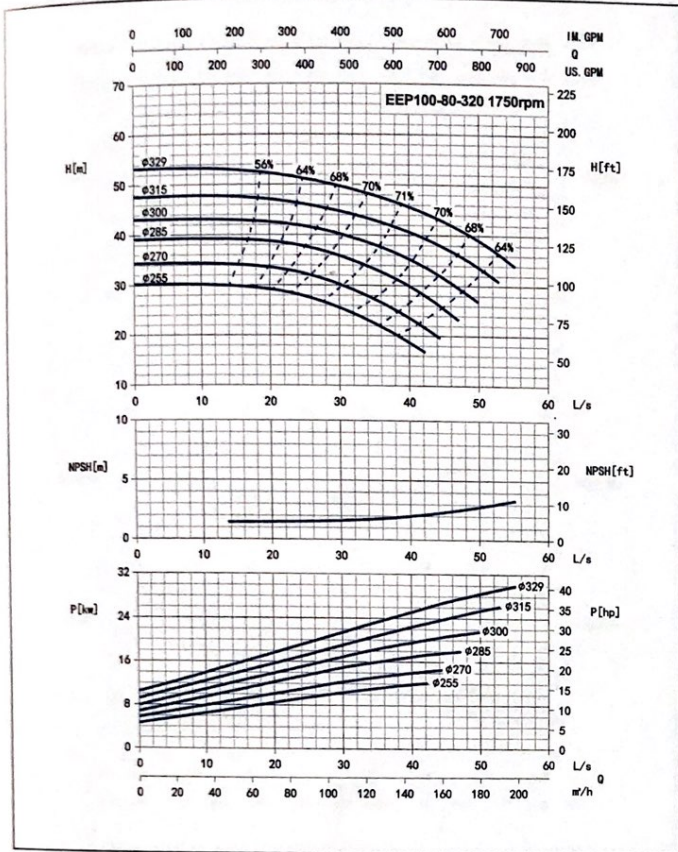

End Suction Centrifugal Pump

